

# **CoLi3Do™ 3.0 Wifi 3D Printer**

# **USER MANUAL**

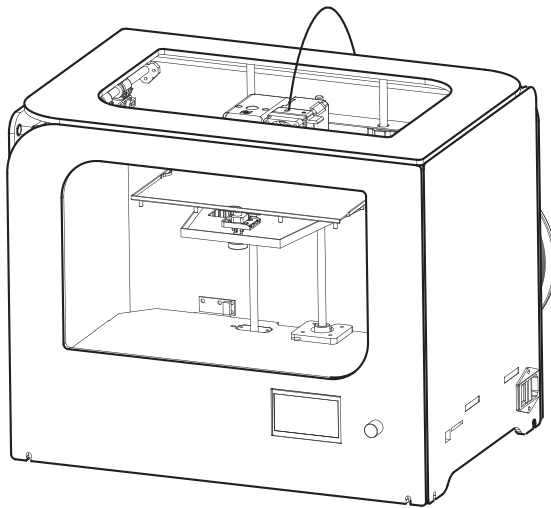

\* Carefully and thoroughly read this manual before using

Visit us at [www.colido.com](http://www.colido.com)



Chapter 1 Introduction .....	03
Chapter 2 Safety and Compliance	
Safety Alert Symbol .....	04
Interference of Radio and Television .....	05
Chapter 3 Specification .....	06
Chapter 4 Print Principle .....	07
Chapter 5 Set up CoLiDo Printer	
5.1 Unpack Printer .....	08
5.2 Accessory Checklist .....	09
5.3 Take out 3D Printer from packing box .....	10
5.4 CoLiDo 2.0 Plus Desktop 3D Printer Structure Illustration .....	11
5.5 Release Printer Head .....	12
5.6 Install camera .....	13
5.7 Install Spool Holder .....	14
5.8 Mount Filament .....	15
5.9 Load the Filament to Printer Head .....	16~17
5.10 Install Glass Platform .....	18~19
5.11 Power on CoLiDo- Printer .....	20
Chapter 6 CoLiDo Printer Calibrate and Test	
6.1 Main Menu .....	21
6.2 Calibrate Mode .....	22~25
6.3 Nozzle & Filament Test .....	26~27
6.4 Print test with SD Card .....	28~29
6.5 Filament detector and recovery system .....	30
6.6 Prepare Menu .....	31
6.7 Change Filament .....	32~33
6.8 Control Menu .....	34~35
6.9 Print from SD Menu .....	36~37
Chapter 7 Install and set up REPETIER-HOST to print	
7.1 Install REPETIER-HOST .....	38~41
7.2 REPETIER-HOST Setup .....	42~44
7.3 Print with Repetier-Host .....	45~47
7.4 Printing using WIFI communication .....	48~59
7.5 Repetier-Host Basic 3D Printing .....	60
7.6 Repetier-Host Advanced 3D Printing .....	61~67
Chapter 8 Maintenance .....	68
Chapter 9 Display Error FAQ .....	69
Chapter 10 Troubleshoot .....	70~72

This User Manual is designed to start your journey with CoLiDo Desktop 3D Printer in the right direction.

In Chapter 1~5, you can learn the basic knowledge of CoLiDo Desktop 3D Printer, how to unbox safely, how to setup correctly. In Chapter 6~10, you can learn how to calibrate the platform, how to print, how to maintain and how to troubleshoot.

Welcome you to the world of CoLiDo Desktop 3D Printer.

Following this manual will help you fully understand the Printer and make amazing products.

In this manual, Safety Alert Symbol will be marked in the start of safety message. The Safety Alert Symbol means potential safety hazards which will possibly harm you or others and cause product or property loss.

### Safety Alert Symbol



**WARNING: HOT SURFACE, DO NOT TOUCH**

Desktop 3D Printer has high temperature when working.  
Make sure the Desktop 3D Printer cool down before touching inside.



**WARNING: HAZARDOUS MOVING PARTS, KEEP FINGERS AND OTHER BODY PARTS AWAY**

The moving parts of Desktop 3D Printer will possibly cause harm. Do not touch the Desktop 3D Printer inside when the printer is working.



**WARNING: Make sure stand by Desktop 3D Printer when it working.**



**CAUTION: Be careful when using Print-Rite unapproved material, which may damage Printer and impact print quality.**



**CAUTION: Disconnect power plug from power socket during emergency.**



**CAUTION: Power socket must be located near the Printer and within reach.**



**CAUTION: Place Desktop 3D Printer in well-ventilated area as it will melt plastic and emit plastic odor when printing.**



### Interference of Radio and Electromagnetism

The Printer has been tested and certified to comply with the restriction of FCC Part 15, which is related to Class B digital facility.

The restriction is designed to provide reasonable protection against harmful interference in residential area when install the Printer. The Printer will generate, apply and radiate Radio Frequency Energy. If the Printer is not installed and used in accordance with the manual, it may cause harmful interference to radio communications. However, there is no warranty to the interference if the Printer is installed in a special environment. If the Printer does cause harmful interference to the receiver of radio or television, which can be determined by turning on and turning off the Printer, the user is suggested to adopt below one or more methods to eliminate the interference:

1. Change the orientation and location of the receiving antenna.
2. Increase the distance between the Printer and the receiving device.
3. Connect the Printer and the receiving device separately with two power sockets in different power supply circuit.
4. Get help from the dealer of the Printer or an experienced radio/TV technician.

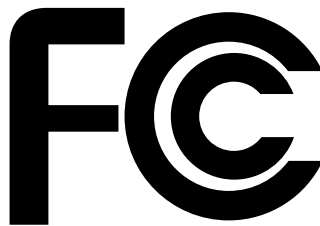

## Printing

---

Print Technology: Fused Deposition  
Modeling  
Construction Dimension: 225\*145\*140mm  
Layer Resolution Setting: 0.1~0.4mm  
Positional Accuracy: XY: 0.011mm  
Z: 0.0025mm  
Filament: PLA/ABS/TPU  
Filament Diameter: 1.75mm  
Nozzle Diameter: 0.4mm

## Mechanical

---

Frame: Acrylic  
Platform: Coated glass  
XYZ Bearing: Steel  
Stepper Motors:  
1.8° step angle,  
1/16 micro-stepping

## Electrical

---

Storage Temperature: 0 °C ~ 32 °C [32 °F~ 90 °F]  
Operating Temperature: 15 °C ~ 32 °C [60 °F~ 90 °F]  
Power: 220W  
Input Voltage: 220V 50/60HZ

## Dimension

---

Printer Size: 467\*320\*380MM  
Package Size: 580\*435\*555MM  
Net Weight: 10.5KG  
Gross Weight: 18KG

## Software

---

Software package: REPETIER-HOST  
File Type: .STL, .GCO  
Operating System: WINDOWS 7, MAC OS  
Connection: USB, SD Card, Wifi

CoLiDo Desktop 3D Printer makes solid, three-dimensional objects by melting PRINT-RITE PLA/ABS filament.

The designed 3D files are converted into CoLiDo command through computer software“Repetier-Host”and sent to the CoLiDo printer via SD Card , USB Cable or Wifi. Then, the printer will heat up and melt PRINT-RITE PLA/ABS filament and push it out from the nozzle to make a solid object layer by layer.

This method is called Fused Deposition Modeling or FDM.

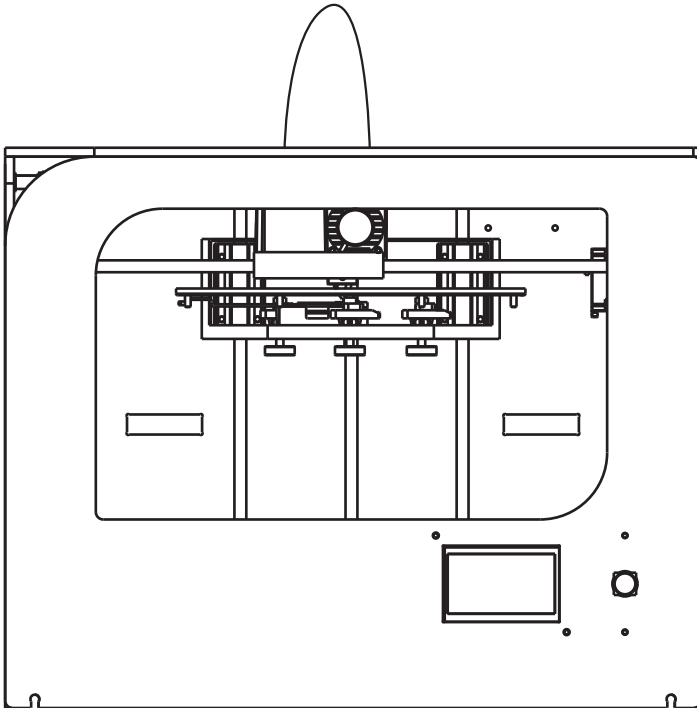

Before setting up CoLiDo Printer, please note that the Printer has been inspected and packed carefully at the manufacturing facility.

Hope you can take more time to unpack carefully and set it up.

## 5.1 Unpack CoLiDo Printer



**CAUTION:** Do not forcibly tear anything when unpack and setup CoLiDo Printer. It may damage the Printer.



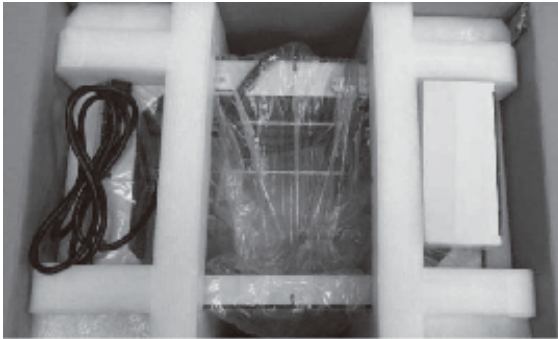





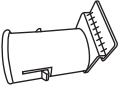

- 1 Place the printer package box on a dry and flat surface when opening.

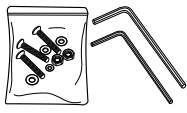

- 2 Take out all accessories inside the Printer box.  
Please refer to the Accessory Checklist at next page.

NOTE: In case there are any missing accessory, kindly email the Printer serial number, name and qty of missed accessory to [3Dsupport@utec.com.mo](mailto:3Dsupport@utec.com.mo).

## 5.2 Accessory Checklist

PLA Filament 1 Cartridge (500g) .....	
Spool Holder 1PC .....	
SD Card 1PC .....	
Power Cable 1PC .....	
USB Cable 1PC .....	
Tools 1 Set .....	
SD Card Reader 1PC .....	
Camera 1PC .....	
PLA Glass Platform 1PC .....	
ABS Glass Platform 1PC .....	
Adhesive Tape .....	
3D printed samples 1 Set .....	

## 5.3 Take out CoLiDo Printer from packaging box

---

- 1 Hold firmly the package foam of the Printer as shown on picture. Carefully lift up the printer when taking it out of the box. Place the Printer on flat ground and carefully remove the package foam and bag of the Printer.



**NOTE:** Do not pull or twist the cable at any time.

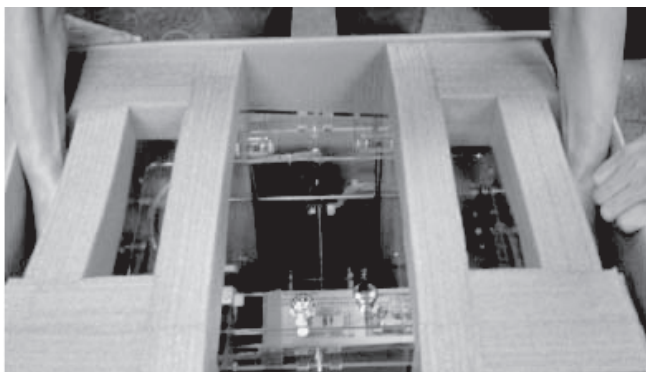

- 2 CoLiDo Printer is unpacked. Please keep the packing material in good shape. It will be re-used in the future to avoid unnecessary damage during transportation.



**NOTE:** Please keep the packing material in good shape. It will be re-used in the future to avoid unnecessary damage during transportation.

# 5.4 CoLiDo 3D Printer Structure Illustration

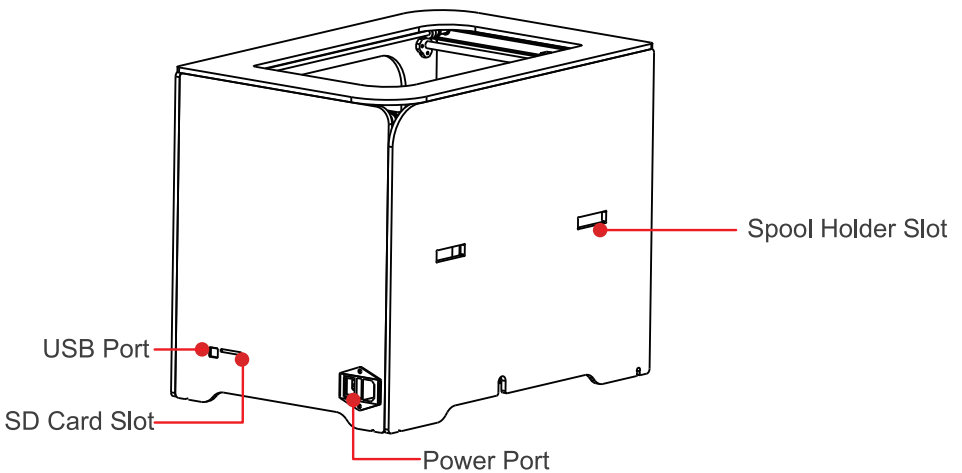
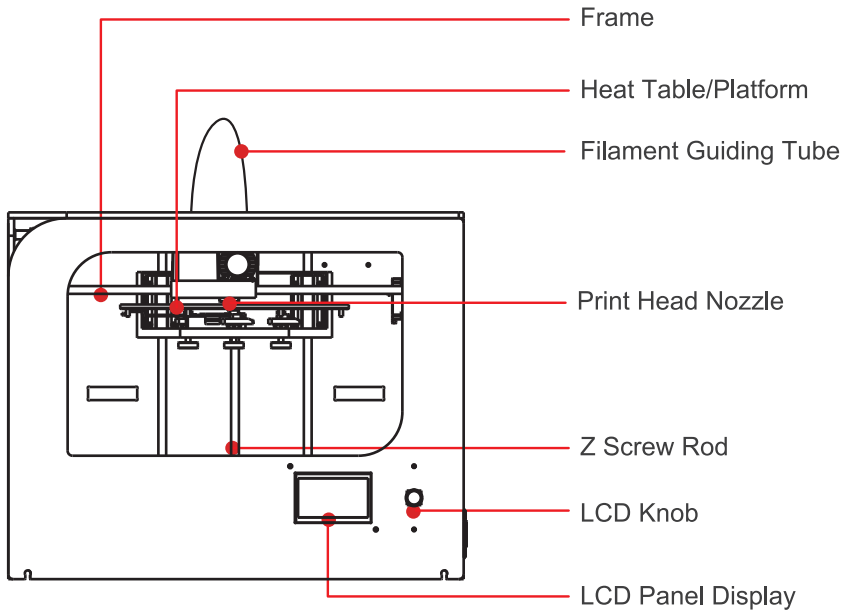

## 5.5 Release Printer Head

- 1 Remove the two locking brackets to release the printer head.  
(Use the Allen Key in the Accessory to unlock the screws)

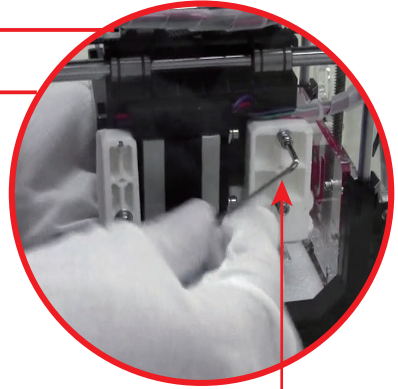
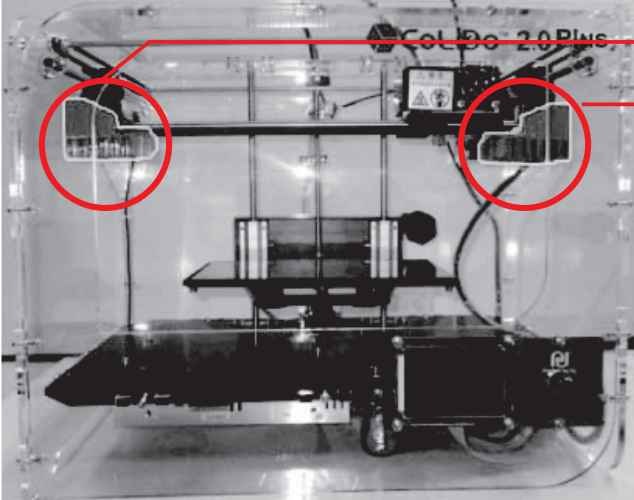

Allen Key

**NOTE:** Printer model please refer the actual model.

- 2 Remove the tape then remove plastic foams under the platform.

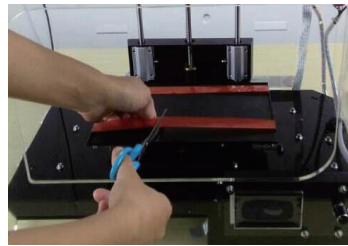
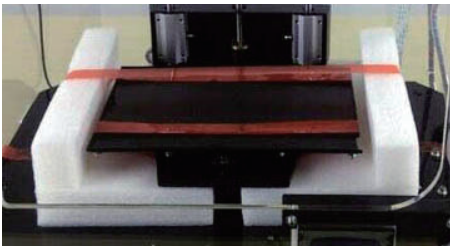



## 5.6 Install Camera

- 1 Connect the camera to the printer by USB cable.

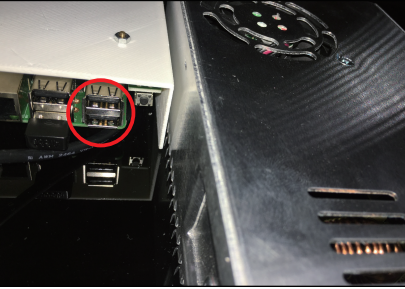

- 2 Put the magnetic strip on the top of the printer, stick the camera on the magnetic strip. (you can adjust the camera location base on what you want)



## 5.7 Install Spool Holder

---

Insert Spool Holder into the Spool Holder Slot located at the back of the printer and put down to lock as shown below.

(Back view of the Printer)

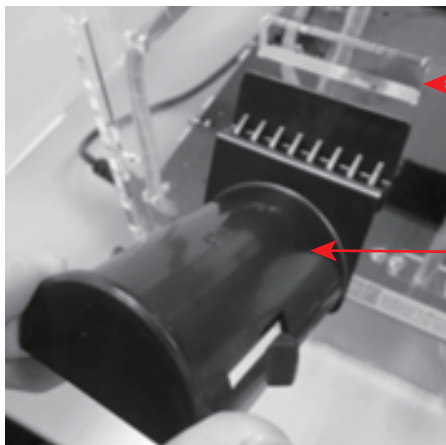

Spool Holder Slot

Spool Holder

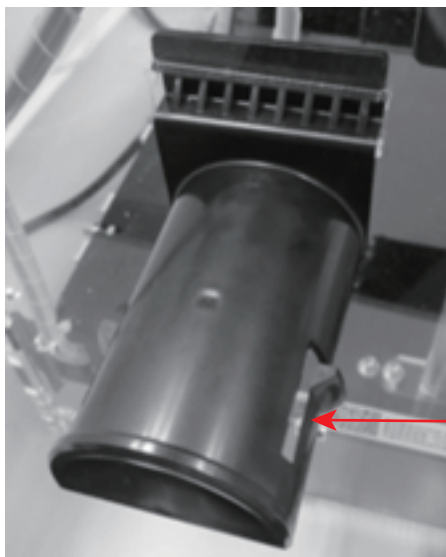

Spring of Spool Holder

## 5.8 Mount Filament

- 1 Take out filament cartridge from the box and remove the vacuum bag.



- 2 Mount filament cartridge on the spool holder and lock by the spring of the spool holder.

**NOTE:** The black thumb pin and the printed "Note" must be facing front.

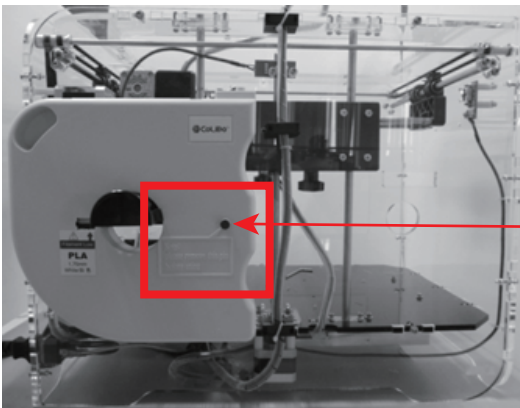

- 3 Remove the black thumb pin to release filament.



**NOTE:** To avoid damage to the cartridge, do not pull filament until:

1. Black thumb pin is removed.
2. Cartridge is installed into the printer.

## 5.9 Load the Filament to Printer Head

- 1 Gently pull the filament from the cartridge.  
Cut the filament tip flat using scissor for easy installation.

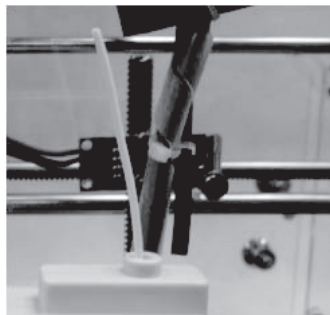
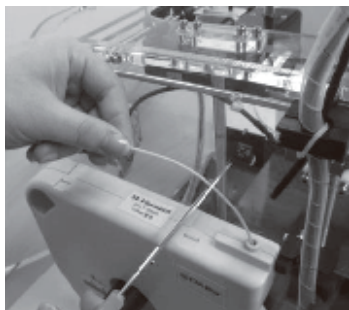

- 2 Insert filament into the Filament detector (see below picture) until it comes out from the other end of the tube.

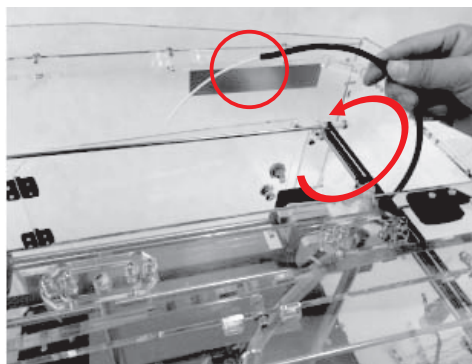
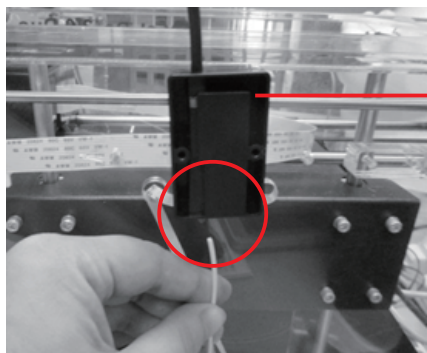

Filament detector

**NOTE:** Make sure that the Filament is inserted into the tube properly to avoid filament jam during operation.

Do not push back excess filament into the cartridge.

Ensure that the filament is mounted on the left of the printer (Back view of the Printer) and rotate counterclockwise direction.

## 5.9 Load the Filament to Printer Head

- 3** Push down the Printer Head arm.  
Insert the filament into the hole located on the top of Printer Head.  
It is better to make the filament more straight and insert it until reach the end of the nozzle.

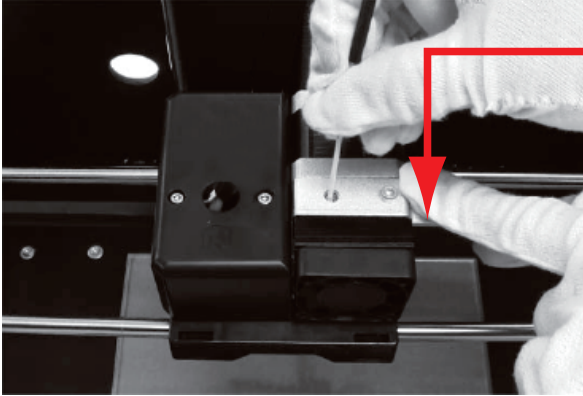

Printer Head arm



- 4** Push and release the Printer Head arm to lock the filament.

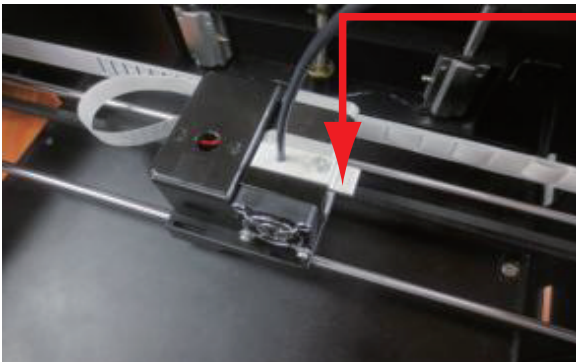

Printer Head arm

## 5.10 Install Glass Platform

---

- 1 Get two Glass Platforms from package .  
Select Glass Platform according to the selected filament material that will be used. The two platforms are coated Glass Platform which mark “PLA” or “ABS” to distinguish.



Coated Glass Platform

### NOTE:

1. Do not change the platform heating temperature setting to avoid the printed object not sticking on the platform.  
(PLA platform: 65~70°C, ABS platform: 100~110°C)
2. Clean the glass platform using lint-free cloth or wet tissue. Don't use alcohol or any cleaning chemical solution in cleaning the glass platform, it will damage the glass coating.
3. Please wait for the platform temperature to cooldown (25~30°C) before removing the printed object. Quickly removing the printed object will cause damage on the printed object and/or glass coating.

## 5.10 Install Glass Platform

- 2 Install the Glass Platform to the Heat Table of the Printer and locked by 2 spring sheets in the Heat Table.

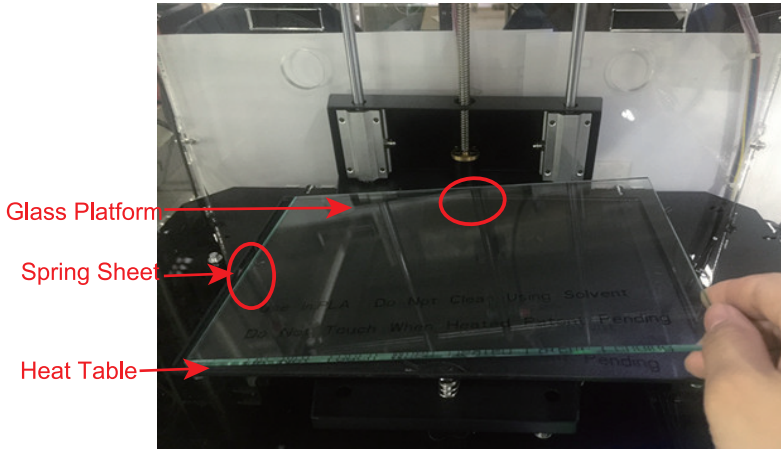

- 3 To uninstall the Glass Platform, push the right lower corner as below picture.

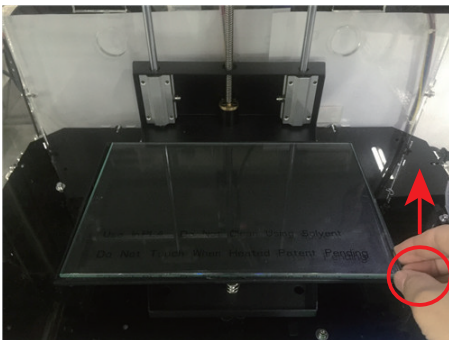

## 5.11 Power on CoLiDo Printer

Connect Power Cable to the Printer



**NOTE:** Make sure printer switch is at “O” position.



- 1 Plug-in the power cable to AC power source.

**NOTE:** The socket-outlet should be installed near the printer and should be accessible.

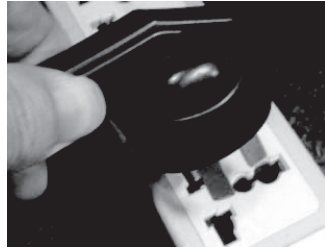

- 2 Properly insert the SD Card in SD Card slot. (SD card stores .gco files to print directly)

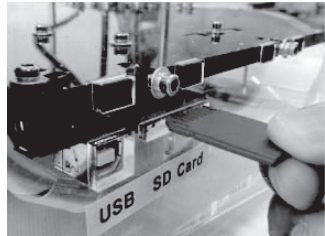

- 3 Power on the printer by switching to “I” position as shown.

**NOTE:** Each time to turn off the printer, please wait for more than 60 seconds to turn it on again.



**CAUTION:** Only use the Power Cable included in the package. Power Supply Socket should be near to the Printer , such the power can be disconnected easily in case of emergency.



# Chapter 6 CoLiDo Printer Calibrate and Test

## Initial display of LCD Panel

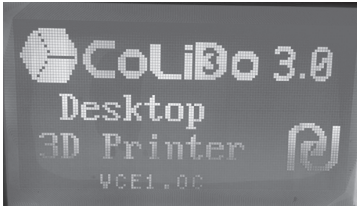

NOTE: The printer version is depended on the shipped printer.

## 6.1 Main Menu

6.1.1 Push the LCD knob to go to main menu and you can see three submenus (picture A).

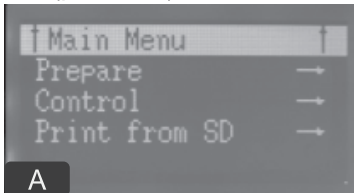

6.1.2 Rotate the LCD knob and select “Prepare”(picture B), then push the LCD knob to go to “Prepare” submenu. (picture C)

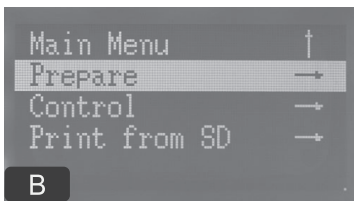

6.2.1 Rotate the LCD knob and select “Calibrate Mode”(picture D), then push the LCD knob to start the calibration .

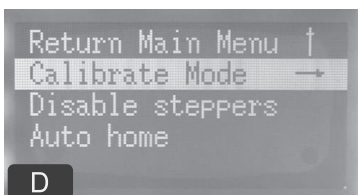

NOTE: “Calibrate Mode”is to guide user to operate the printer and to check the printer work well.

## 6.2 Calibrate Mode

6.2.2 The platform will move up and the printer head will go to the 1st location Point 1 (picture E) and the LCD Display screen will show as picture F.

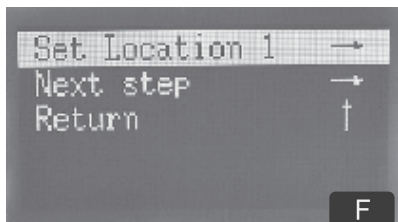

6.2.3 Start to calibrate the table and nozzle.

6.2.3.1 Sound assist system: When start calibrate mode, there are two types of the buzz sound to assist the calibration.

1. Short buzz sound: that means the calibration is not correct.
2. continued buzz sound: that means the calibration is correct.

## 6.2 Calibrate Mode

### 6.2.3.2 Calibration Standard Condition:

The continued buzz sound: The gap between nozzle tip and glass Platform are in the good condition.

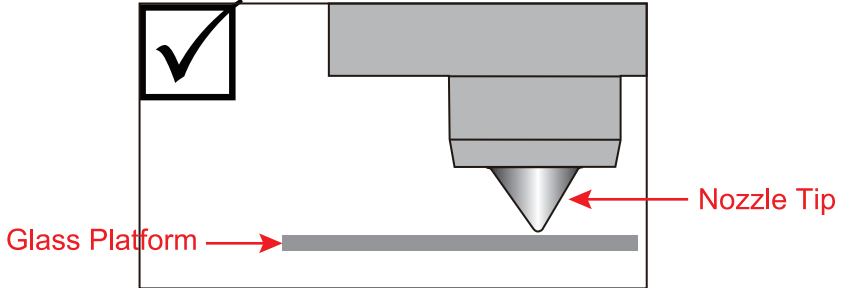

Note: If the calibration standard condition is not met, platform level must be adjusted.

Condition 1: There are no sound at all.

Adjustment 1: Rotate the adjusting knob under the platform clockwise until the printer make continued buzz sound as standard condition.

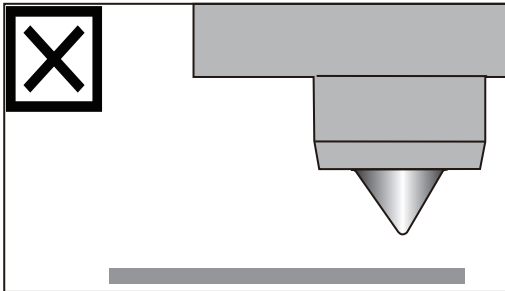

Condition 2: Short buzz sound.

Adjustment 2: Rotate the adjusting knob under the platform counterclockwise until the printer make continued buzz sound as standard condition.

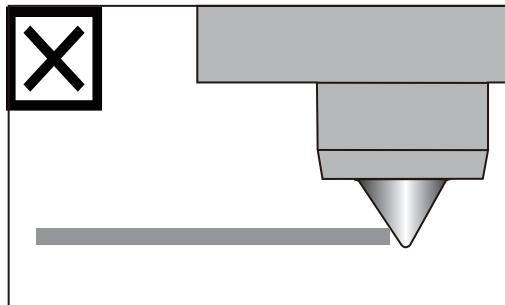

## 6.2 Calibrate Mode

6.2.4 When the sound assist system not stable or not working well, please follow the steps below to calibrate the printer.

To adjust the gap between glass platform and nozzle, please follow the refer pictures below to visually adjust the printer:

When look throught reflection image o the glass platform, the nozzle tip and the platfor have big gap (As Fig. A), please rotate adjusting knob clockwise to rise up the platform until the nozzle tip and the reflection nozzle tip image just meet together to stop rotating. (As Fig.B)

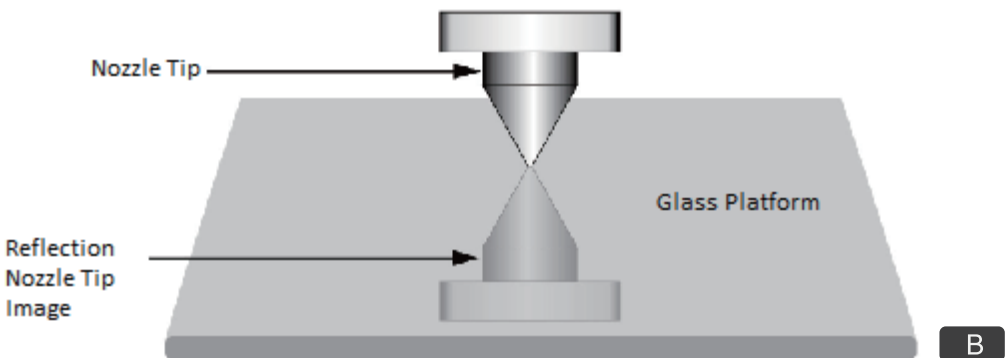
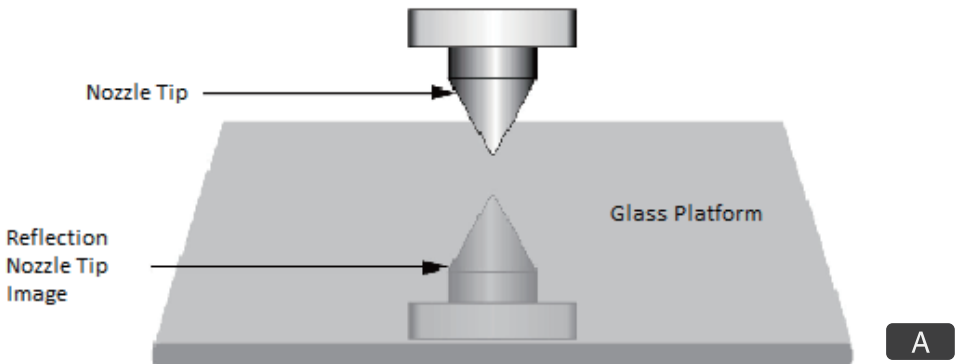

## 6.2 Calibrate Mode

The adjusting knob location as picture H (total 3PCS).

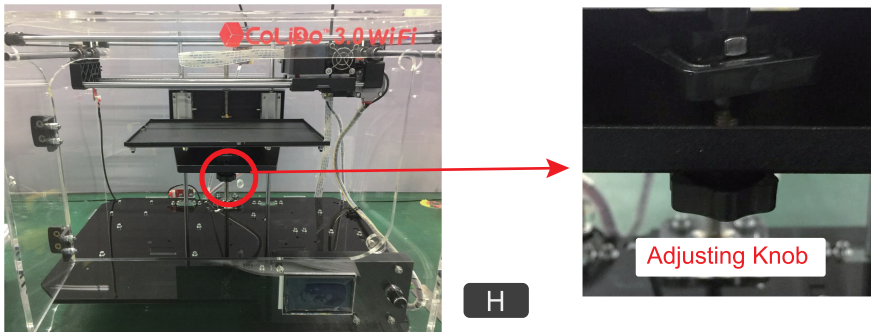

6.2.5 After rotate the adjusting knob to meet the Calibration Standard Condition, rotate the LCD knob to select “Next Step” as picture I, then press the LCD knob to next point to calibrate.

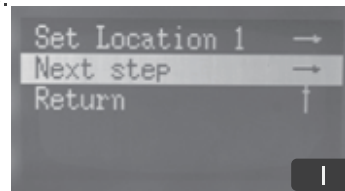

6.2.6. Follow 6.2.3 and 6.2.4 procedure to calibrate point 2,3 and 4 as picture J.

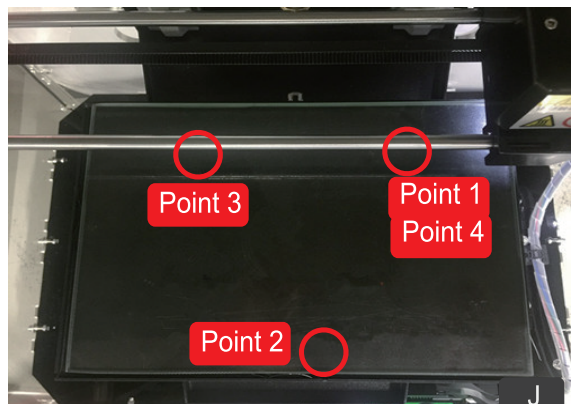
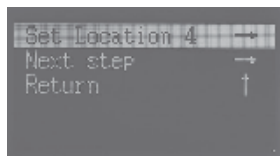
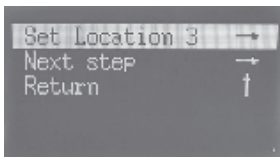
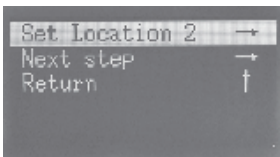

## 6.3 Nozzle & Filament Test

6.3.1 After calibration, the screen will show Picture K, push the LCD knob to select the filament you are using.

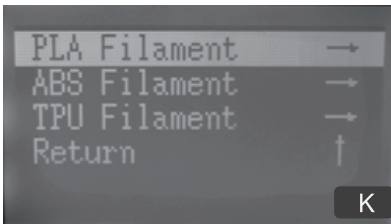

6.3.2 The screen will show Picture L, make sure the filament is inserted into the printer head correctly.

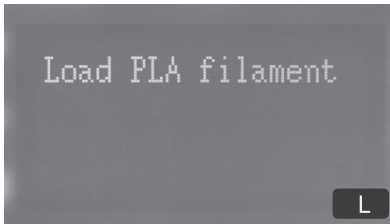

6.3.3 The nozzle will start to heat up as picture M. Once the nozzle actual temperature reach the setting temperature as picture N, the filament will auto load into the nozzle and flow out from the nozzle.



NOTE: the setting temperature for PLA and ABS is different as below. Incorrect temperature setting will result to printer damage.

Nozzle Setting Temperature

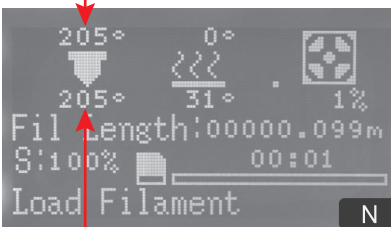

Nozzle Actual Temperature

Filament	Nozzle Setting Temperature
PLA	205°C
ABS	230°C

## 6.3 Nozzle & Filament Test

6.3.3 Check the melted filament flow condition base on below instruction.

- If good condition as picture O, the printer will go ahead to test printing.
- If no good condition as picture P, push the LCD knob to show screen as picture Q and select “Stop Calibrate” to return to main menu.

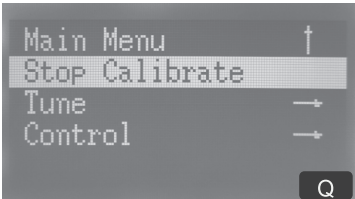

Good condition:

The melted filament flow out smoothly and continuously from the nozzle.



No Good condition:

The melted filament do not flow out smoothly and continuously from the nozzle.



**Note:** If the filament flowing is in No Good condition, check the following.

- Nozzle Temperature - must be the equal to the set temperature and according to the filament material melting temperature.
- Nozzle Cleanliness - No Clogging by refer to troubleshoot clogged nozzle label on the front of the printer.
- Filament Insertion on the receiving port correctly.

If problem still occur kindly email  
3Dsupport@utec.com.mo

## 6.4 Print test with SD Card

6.4.1 After nozzle and filament inspection, the screen will show as below picture R. The printer will start to heat up the platform a few minutes.

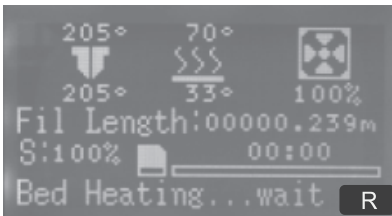

NOTE: If screen shows no test file such as picture S, means that the test file cannot be found on SD card. Check the following.

1. Check if the SD Card is inserted into the SD card slot well.
2. Check if the test file is saved in the SD Card. The test file name will be updated based on the shipped printer.

(For example:

PCT1.gco for PLA filament and  
ACT1.gco for ABS filament)

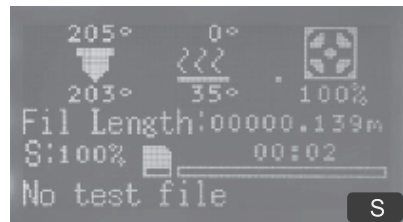

6.4.2 Once the platform temperature reaches the setting temperature as picture T, the nozzle will heat up next as picture U.

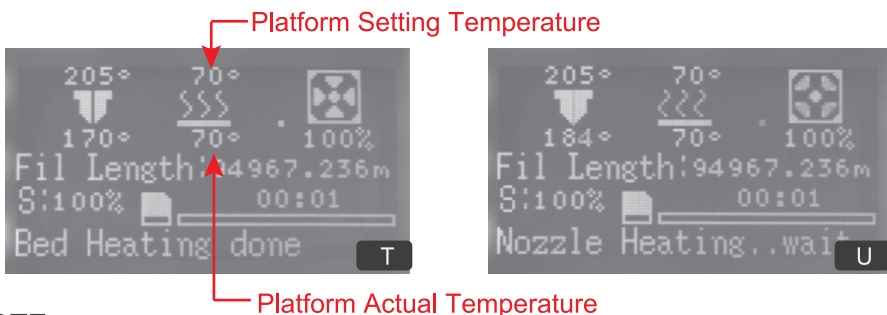

NOTE:

The platform setting temperature for PLA and ABS is different. Incorrect temperature setting will result in the object sticking on the platform.

Filament	Nozzle Setting Temp	Platform Setting Temp
PLA	205°C	65~70°C
ABS	230°C	100~110°C



## 6.4 Print test with SD Card

6.4.3 Once the nozzle temperature reach the setting temperatuer (Picture V), the heating is done and the printer start to print.



6.4.4 Finish printing the test file, the LCD Display will show as picture W. The platform and the nozzle will start to cooldown.

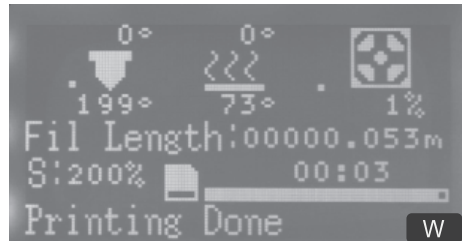
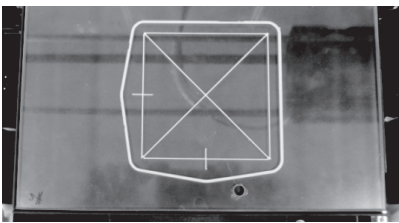

**NOTE:** Please wait for few minutes to cooldown the platform before removing the printed object.

### 6.4.5 LCD Display Screen Definition

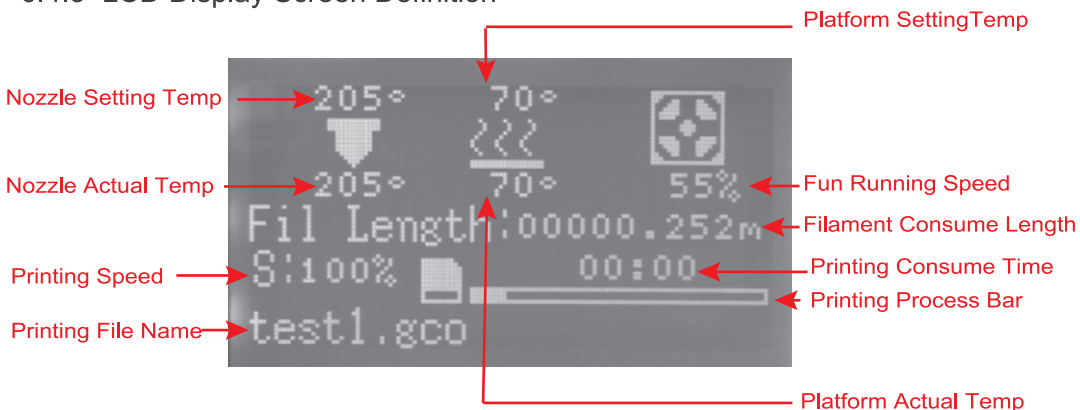

## 6.5 Filament detector and Recovery system

### 6.5.1 Filament detector

When filament used up or broken, the printer will stop print and LCD display will shown as Fig. A. Please prepare new filament and select “Resume print” (As Fig. B). Press down the print head arm and push down the remain filament about 1cm when the nozzle reach to the target temperature, then pull it out (Fig. C) Please refer chapter5.8 to load new filament.

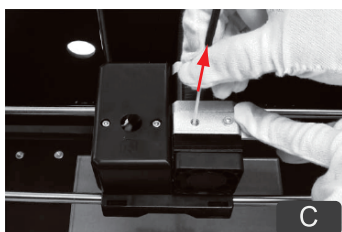

**Note:** Please clean the remain filament on the nozzle. The G-code must be save in the SD card to print if use the filament detector.  
(It must be NOT save in the submenu)

**Note:** Wait more than 60 second to restart the printer if you turn it off.

### 6.5.2 Recovery system

When meet power failure:

Situation 1: If need to continue print after power failure, please use the adhesive tape to fix the print platform and the skirt. DO NOT move the object, priter head and X, Y, Z bearing. After reconnect power, use the LCD knob to select “Resume print”.

Situation 2: If need to re-print object, select “Cancel print”.(Fig.B)

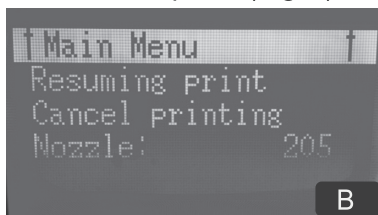
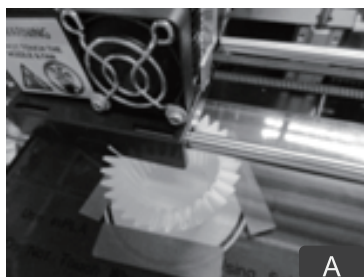

**Note:** Please set up a brim for the object. (Refer Chapter 7.5) The G-code must be save in the SD card to print if use the recovery function.  
(It must be NOT save in the submenu)

## 6.6 Prepare Menu

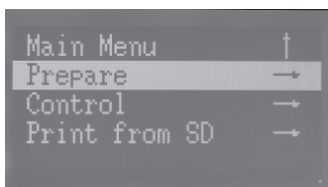

There are 6 submenus under “Prepare” as below picture:

- 1、 Calibrate Mode → Printer calibration and test  
(Refer to 6.1~6.4)。
- 2、 Platform Location →Printer calibration.
- 3、 Disable Steppers→Unlock all motors, can move the position of the platform and the printer head manually.
- 4、 Auto Home→Printer Head will go to initial position.
- 5、 Reset X Home→Printer Head return to X initial position. Y, Z position will not change.
- 6、 Change Filament →Load or unload filament (Refer to 6.6)
- 7、 Cooldown→Cool down the temperature of the platform and the nozzle to normal temperature.



## 6.7 Change Filament

“Prepare”-“Change Filament”has two submenus: (as picture a)

Load Filament

Unload Filament

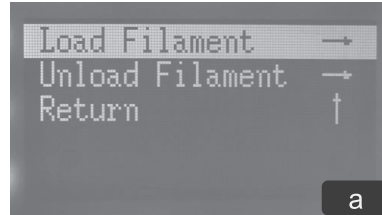

6.7.1. Select“Load Filament”and proceed as below picture b~f.

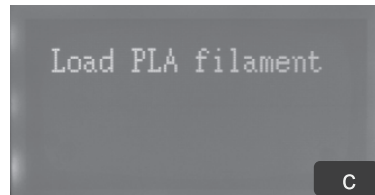
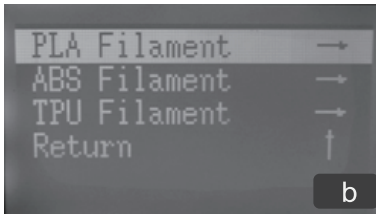

a. Select the filament material you are using

b. Insert the filament to the hole of the printer head

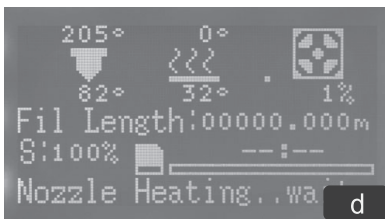

c. Heating up nozzle temperature to the setting temperature

d. Once reach the setting temperature, The filament will be semi-auto loaded into the nozzle and flow out.

Check the filament flowing condition by refer to 6.3.3.

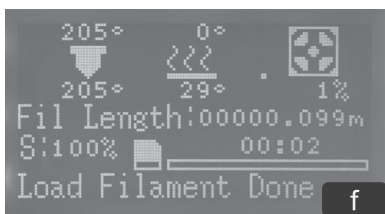

e. Finish the filament loading

## 6.7 Change Filament

6.7.2. Select “Unload Filament” and proceed as below picture g~k.

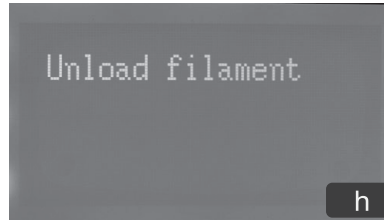

a. Heating up the nozzle temperature to the setting temperature (picture i).

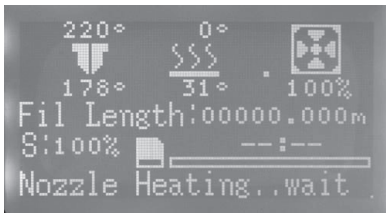

b. Once the temperature reaches the setting temperature as below picture g, the filament will be semi-auto unload from the nozzle.



c. Once the LCD display will show screen as below picture k, finish the filament unloading and gently pull out the filament from the nozzle.

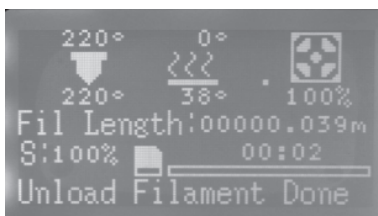

## 6.8 Control Menu



There are 6 submenus under “Control”:

- 1、中文(Chinese) →to change to Chinese Display.
- 2、Temperature →to adjust temperature.
- 3、Speed: 100%→to adjust print speed.
- 4、Printer Runprama →to refer to printer running info.
- 5、Printer Info →to refer to printer basic information.
- 6、Password→Manufacturer setup. Forbit user to adjust.

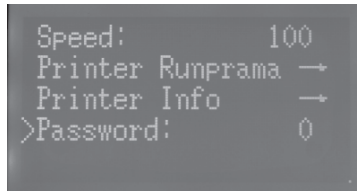
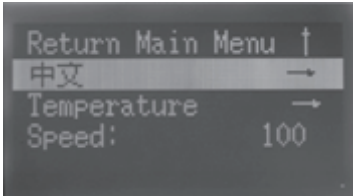

6.8.1 “中文”: The Display has two languages with Chinese (中文) and English. Select the language and push the knob to confirm to change to another language that you want to show in LCD Display as below (Chinese).

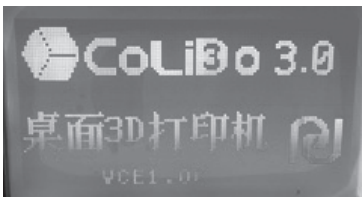

Change Chinese to English: Push the knob, select“参数” - “English”.

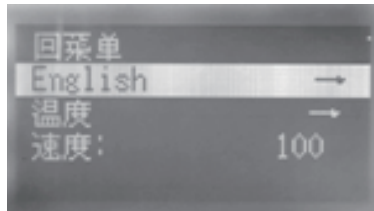
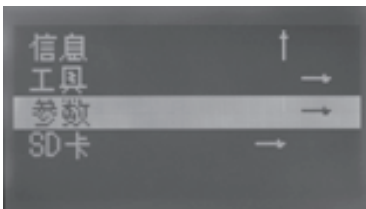

**NOTE:** Once change the language in LCD display, the printer will be restarted. If changing during printing, the printing will stop.

## 6.8 Control Menu

6.8.2 Temperature menu can set up below parameter:

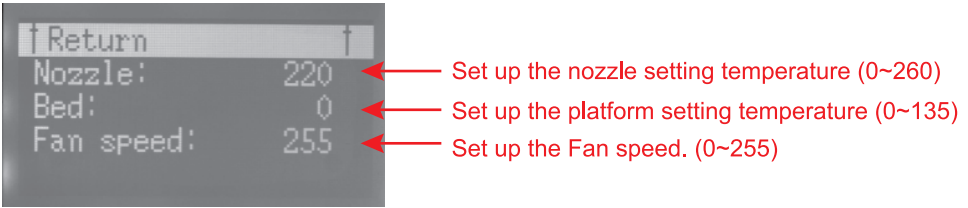

Setting method: Rotate the knob to select the parameter that you want to adjust and push the knob to confirm. Then rotate the knob to adjust the setting you want and push the knob to confirm the number. The parameter will be run to the system.

**NOTE:** 1. Do not adjust the temperature during the heating;

2. When adjust the temperature during printing, need increase or reduce the temperature 5~10°C step by step, or the printing will stop.

6.8.3 “Speed” is to adjust the printing speed during printing. It can be adjusted base on actual condition. The number increases, the printer speed also increases. The number can be set from 10% to 200% and the default speed is 100%.

6.8.4 “Printer Runprama” menu as below.

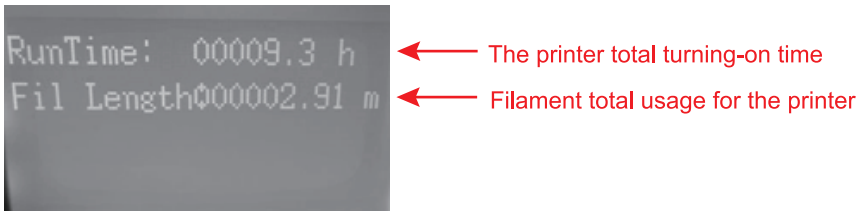

6.8.5 “Printer Info” menu as below.

It is to show the printer basic information such as Printer type, Version No and License No.

The actual Version No and License No will be depend on the shipped printer.

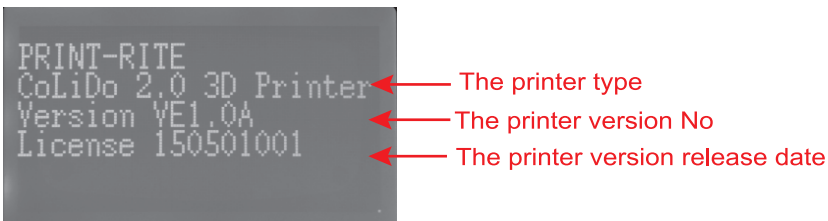

## 6.9 Print from SD Menu

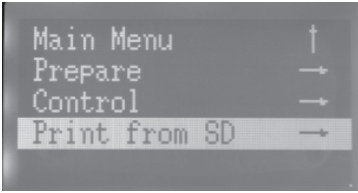

“Print from SD Card” is to select the print file from SD Card to print.

6.9.1 The default documents when out of factory is:

(it will be updated depend on the shipped printer)

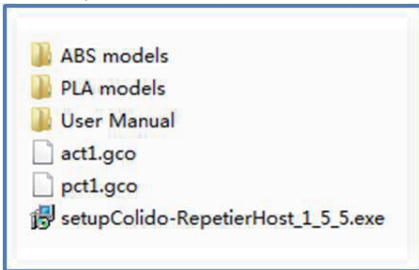

NOTE: PCT1.gco is test file for PLA filament, ACT1.gco is test file for ABS filament.

6.9.2 Rotate the knob to select the print file that you want to print (.GCO file) and push the knob to confirm to start to print the file.

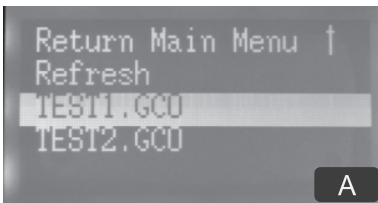

A

Select the print file that you want to print

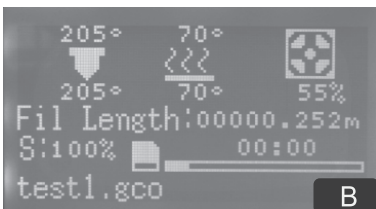

B

Once the platform temperature and the nozzle temperature reach the setting temperature, the printer start to print.

**NOTE:** The printer just can read the G-code (GCO). You can print .GCO file with SD Card directly. Otherwise, you can convert .STL file to .GCO file using software REPETIER-HOST, then save the GCO in SD card to print directly or connect REPETIER-HOST in the computer to print through USB cable .



## 6.9 Print from SD Menu

### 6.9.3 Pause Printing Feature:

1. Push LCD knob and rotate to select “Pause Print”;
2. Push LCD knob and rotate to select “Resuming print” to resume print.

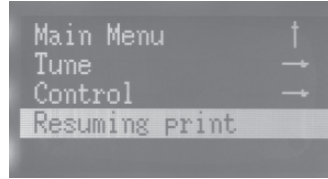
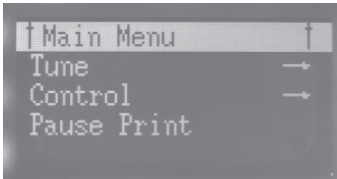

NOTE: When pause printing, the printer head will go to home position and be locked. The nozzle and the platform temperature will keep on.

- a. Please clear up the remained filament outside the nozzle tip before resume printing.
- b. If resume printing after pause long time, please make sure the nozzle no clogged by pressing the printer head arm and pushing the filament into the nozzle until the filament flow out smoothly.

### 6.9.4 Stop Printing Feature:

1. Push LCD knob and rotate to select “Stop Print”;
2. Once stop, the printer head will go to home position. the nozzle and the platform temperature will cooldown.

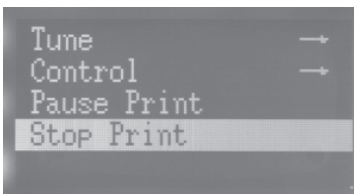

### 6.9.5. Adjust Printing settings Feature:

During printing, rotate the LCD knob and rotate to select “Control”. You can adjust the setting temperature, speed or review the printer information. (Refer to 6.8)

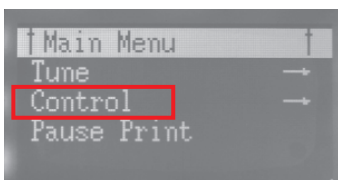

If you want to print files from computer, you need install REPETIER-HOST.  
Computer Operation System: WINDOWS 7, MAC OS

 REPETIER-HOST is a software which is used to slice the 3D models (.GCO or .STL) and command CoLiDo Printer to print.

## 7.1 Install REPETIER-HOST (WINDOWS)

- 1 Find“setupColido-RepetierHost\_1\_5\_5 .exe”in SD Card, double click to start.

Select Setup Language to use during the installation.

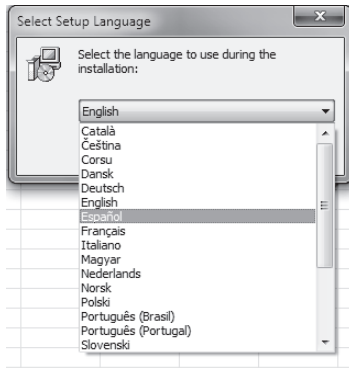

**NOTE:** For the actual version of the software, please refer the version in the SD card.

- 2 Start to install. (You will be asked“Do you want to allow the following program to make changes to this computer?”,please click“Yes”to continue installation.

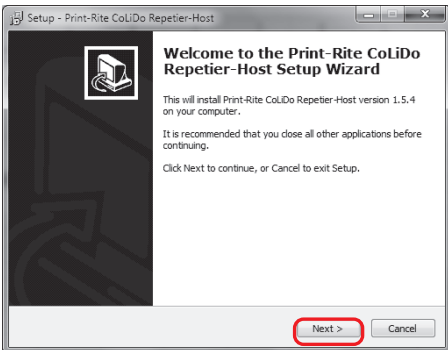

Click“Next”

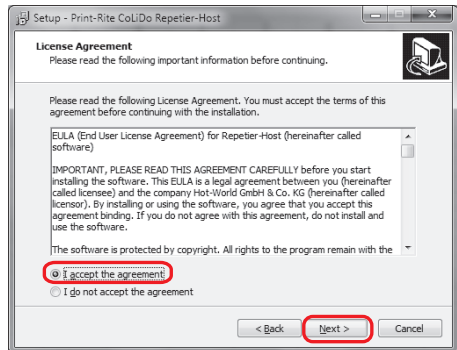

Click“I accept the agreement”,  
Click“Next”

# 7.1 Install REPETIERHOST (Cont.)

**3** Select a destination to save the software and select the components should be installed, then click “Next” and “Install”.

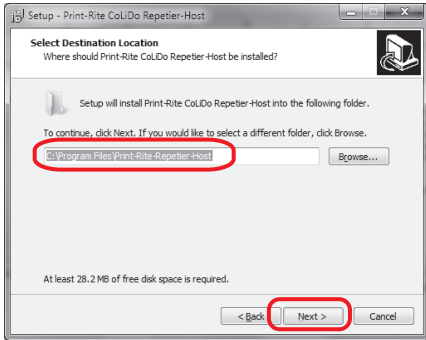

Click “Next”

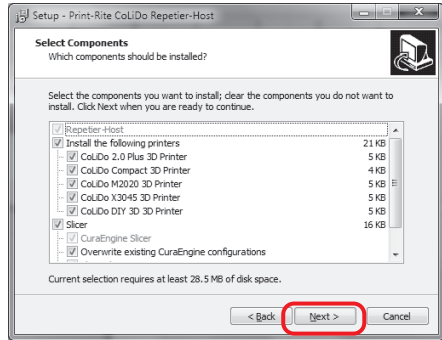

Click “Next”

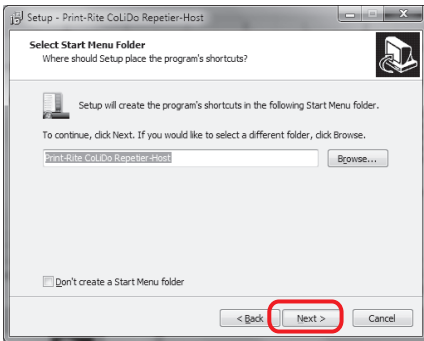

Click “Next”

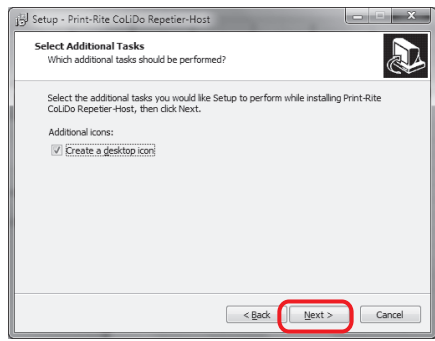

Click “Create a desktop icon”  
Click “Next”

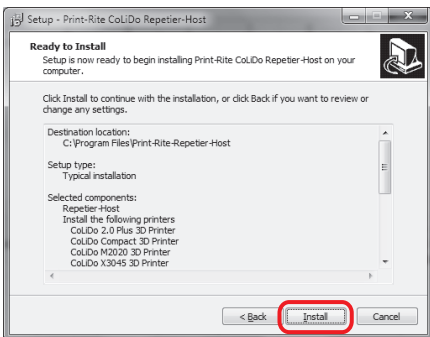

Click “Install”

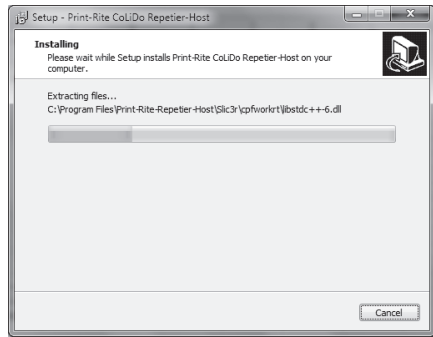

if antivirus message appear, please allow the operation timely.

## 7.1 Install REPETIER-HOST (Cont.)

- 4 Click “Install Arduino driver”, “Install FTDI serial driver” and “Launch Print-Rite CoLiDo Repetier-Host” and then click “Finish”.

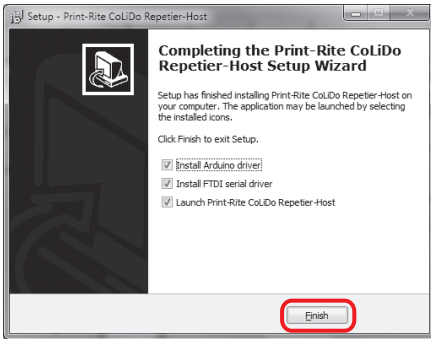

Click “Finish”

- 5 Install Arduino drivers.

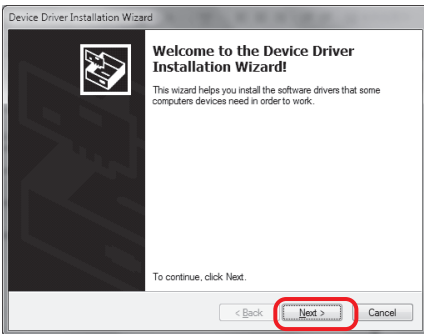

Click “Next”

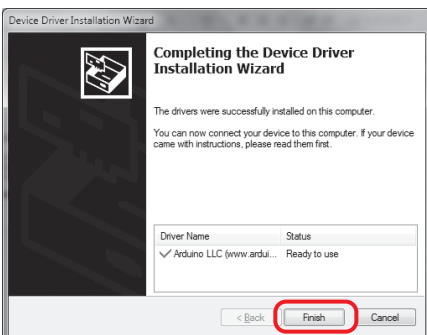
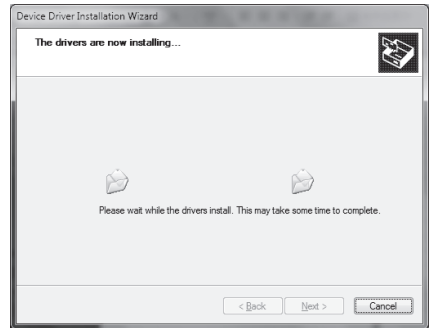

Click “Finish”

# 7.1 Install REPETIER-HOST (Cont.)

## 6 Install FTDI Drivers.

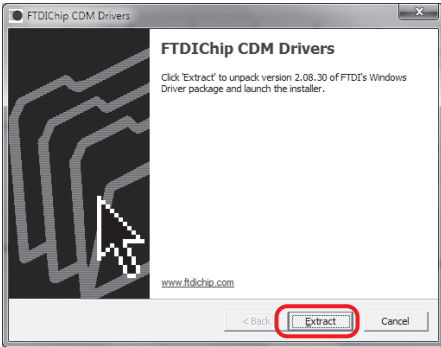

Click "Extract"



Click "Next"

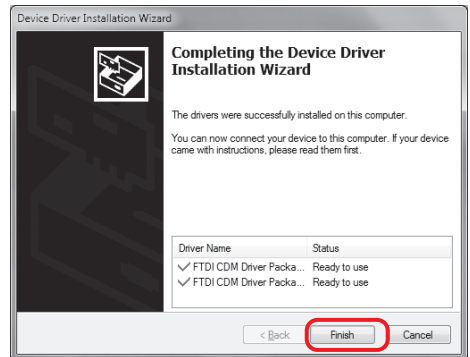
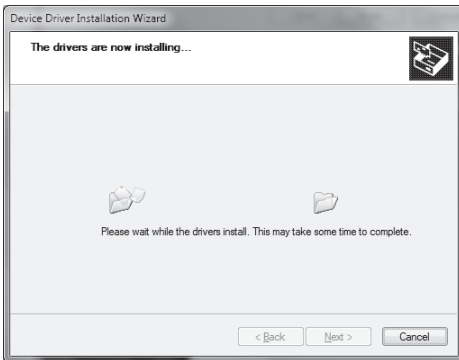

Click "Finish"

## 7.2 REPETIER-HOST Setup

Connect the printer to the computer using USB Cable and Turn ON the printer.

When the computer is the first time connecting the printer, there is connection reminder at the right bottom of the computer.

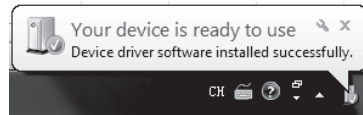
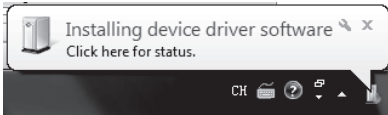

1 double click  to go into “Repetier - Host” software.

2 Select language you want in the software, “Config”- “Language”.

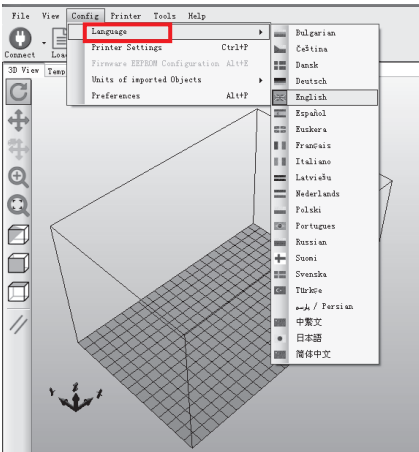

3 click “Printer Settings”.

Printer Settings

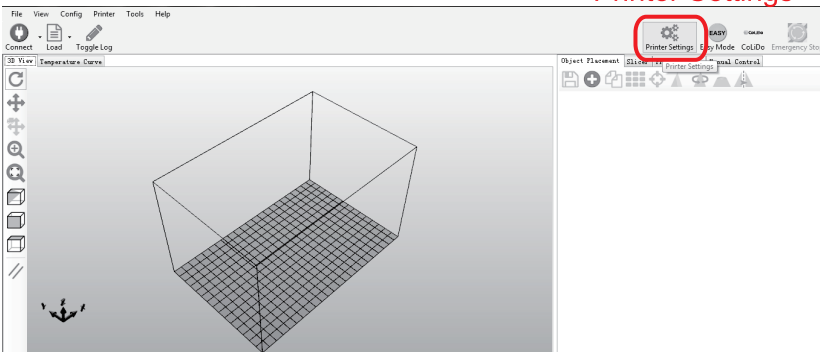

# 7.2 REPETIER-HOST Setup (Cont.)

## 4 Printer Settings as below.

Connection: Select Printer: CoLiDo 2.0 Plus 3D Printer (Be in common use with 3.0); Baud rate: 115200.

Select the correct Port COMx such the printer can connect with the Repetier.

**NOTE: COMx dependant on different computer or 3D printer you are using. Different 3D printer has different COMx, which can be located and matched with COMx in Device Manager as below.**

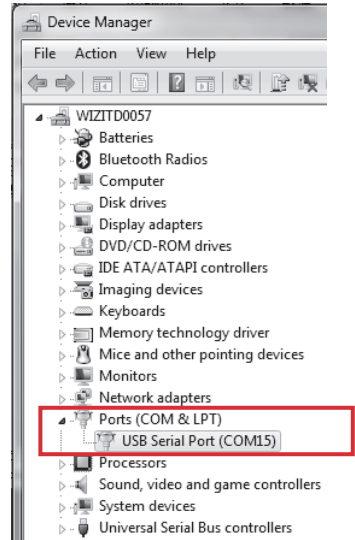
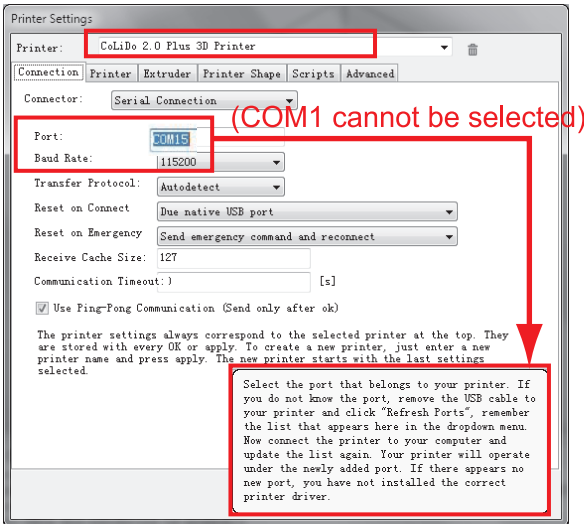

Printer Shape: as below data. After checked, click "Apply" and "OK".

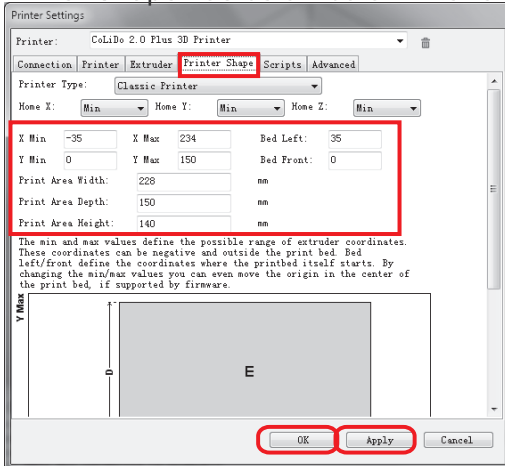

## 7.2 REPETIER-HOST Setup (Cont.)

- 5 Click “Connect”.

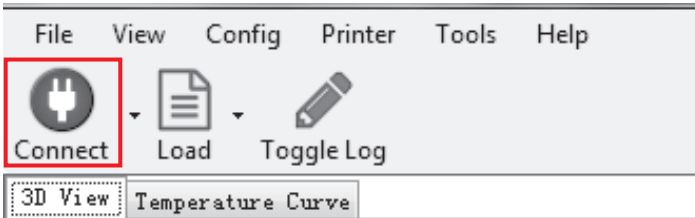

**NOTE:** After the printer is really connected with the Repetier software, the actual extruder and bed temperature of the printer will be shown in the bottom of the Repetier software. Also, the Temperature Curve is moving.

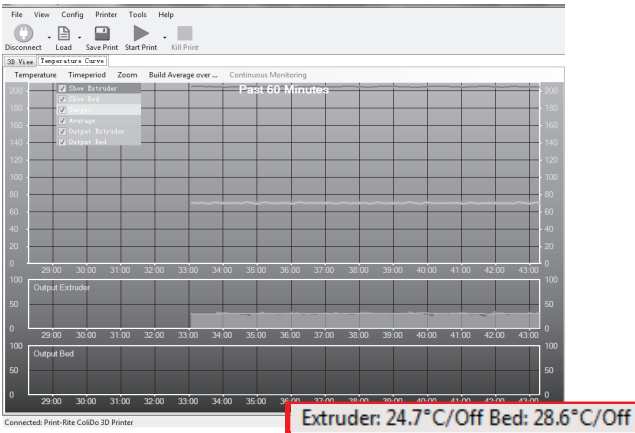

**NOTE:** Once click “Connect” in Repetier Host to connect the printer, the printer will be re-started.

- 6 Click “Load”, select the print file that you want to print and click “Open”.

**Note:** The print file should be with .GCO or .STL format.

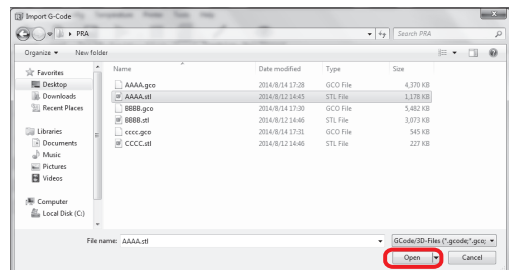
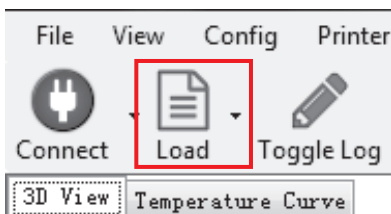



## 7.3 Print with Repetier-Host (Cont.)

- 7** Select the print effect that you want to print, select PLA or ABS filament that you are using. Then click “Slice with Slic3r” to generate G-code.

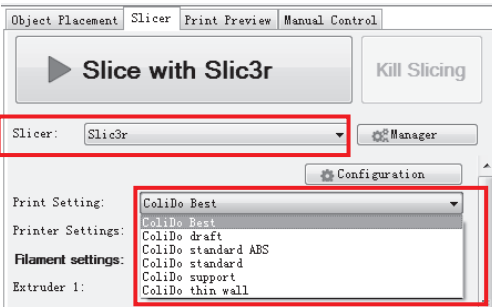

Step1: Select “Slic3r”

Step 2: Select the effect that you want to print

- CoLiDo Best - For small object
- CoLiDo standard - For big object
- CoLiDo standard ABS - For ABS material object
- CoLiDo draft - For fast printing
- CoLiDo support - For the model adding support
- CoLiDo thin wall - For the thickness lower 2mm thin wall object

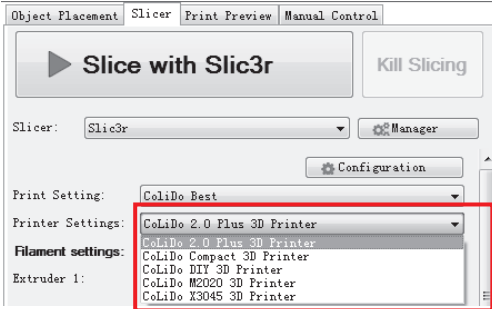

Step 3: Select printer type “CoLiDo 2.0 Plus 3D Printer” you are using. (Be in common use with 3.0)

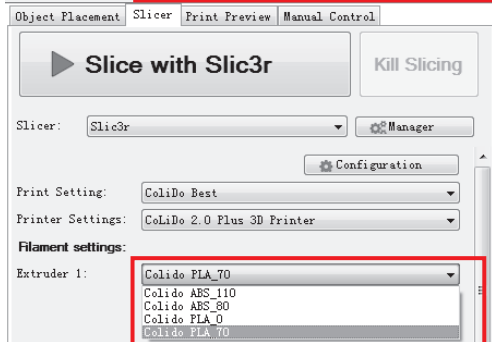

Step 4: Select Extruder base on the PLA/ABS filament you are using and the platform required temperature

- CoLiDo ABS\_110
  - For ABS Filament with platform temp 110°C
- CoLiDo ABS\_80
  - For ABS Filament with platform temp 80°C
- CoLiDo PLA\_0
  - For ABS Filament with platform temp 0°C
- CoLiDo PLA\_70
  - For PLA Filament with platform temp 70°C

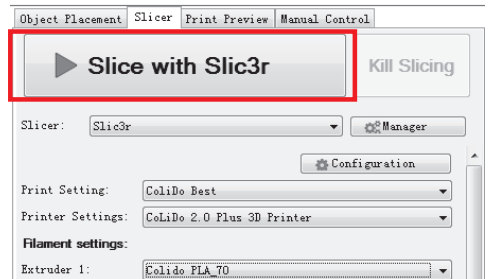

Step 5: Click “Slice with Slic3r” to slice the file to generate g-code

## 7.3 Print with Repetier-Host (Cont.)

- 8 After slice, you can see the estimated printing time and filament usage. Also, you can see the printed shape of the object in the “3D View”.

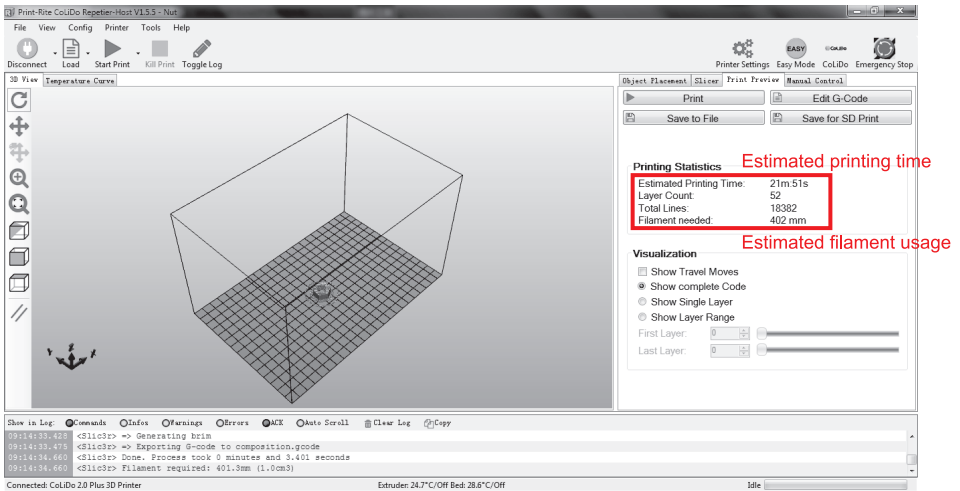

- 9 Click “Print”, start to print.

Once the platform and the nozzle actual temperature reach the setting temperature, the printer will start to print.

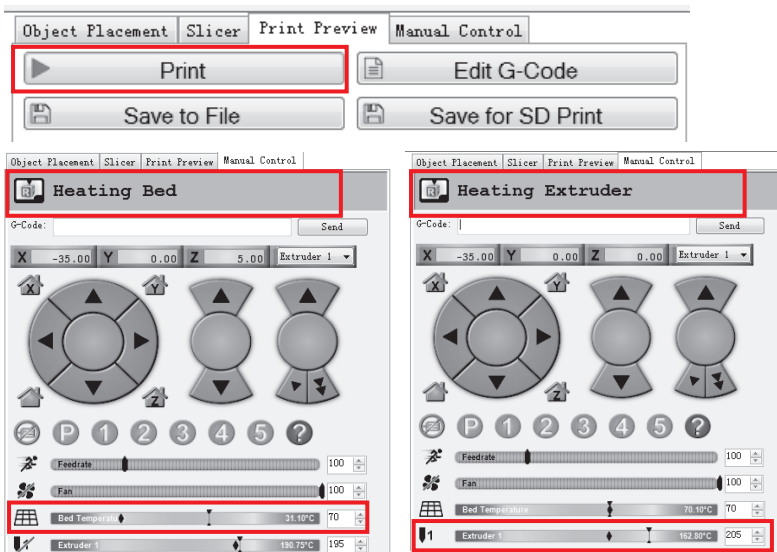

## 7.3 Print with Repetier-Host(Cont.)

### 10 Printing.

1. You can see the printing track from “3D View”;  
You can see temperature go up/down from “Temperature Curve”.

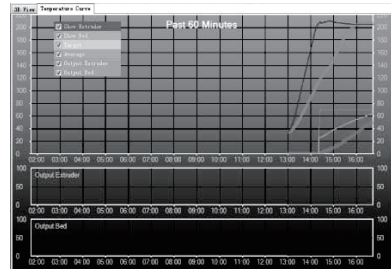
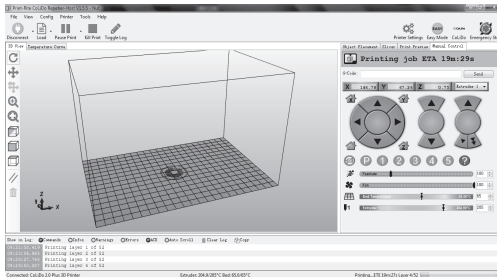

2. You can click “Pause Print” and “Continue Printing” to pause/resume printing.  
You can click “Kill print” to stop the printing and cannot be resumed.

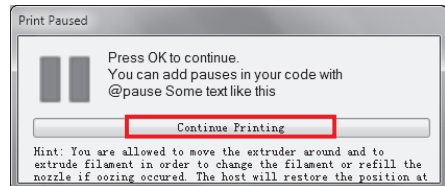
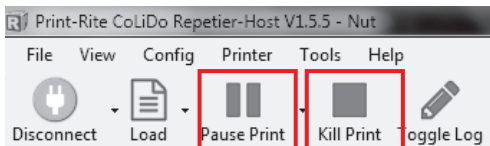

- 11 If want to print the file using SD Card, you can click “Save for SD Print” after slice, to save the GCO file in the computer or SD Card.

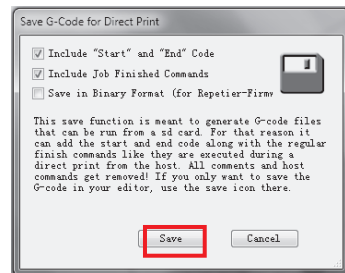
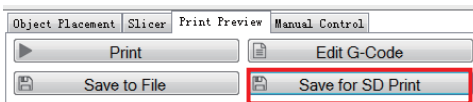

**NOTE:** The saved file name just can be English words, number, underline, blank space.

### 12 Finish Print.



**Caution:** Please wait for a few minutes to cooldown before remove the printed object.

### 13 NOTE:

1. When connecting the computer to the printer to print, need disable the screen saver and sleep settings of the computer, or the printing will stop.
2. When printing using SD Card, please disconnect USB to the computer.

## 7.4 Printing using WIFI communication

7.4 There are two methods of WIFI communication:

- A. WIFI communication: Control printer using local area network (No need internet cable, use printer WIFI hot spot to communicate with printer);
- B. Remote control: Control printer using internet (No need internet cable, use wireless relay to connect with print).

7.4.1 WiFi function cannot use if the printer connect with PC using USB cable.

When printer under the WIFI mode, can operate printer through the web. Reboost printer after disconnect printer with PC, before connect WIFI function.

NOTE: Google Brower only.

7.4.1.1 Connect and login use PC.

- a. As picture shown below, under the WIFI connection to connect “ColidoWifi\_XXXX” and default password is 12345678.



NOTE: Make sure the Wifi USB receiver plug in the printer and the printer is turn on.

Select “ColidoWifi\_XXXX” to connect

## 7.4 Printing using WIFI communication

b. Open Google Browser, input “10.10.11.1” in the address bar, then you can view CoLiDo 3D printer Control system in webpage.

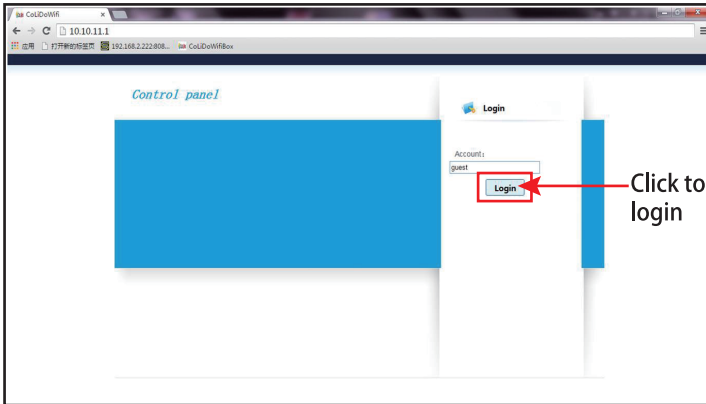

If login with mobile, please select “To PC” to setup relay mode.

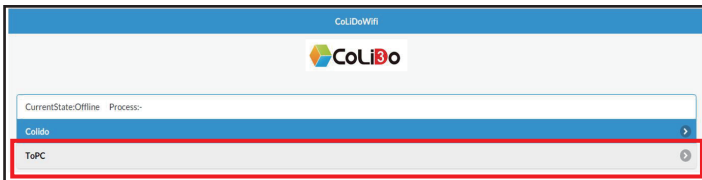

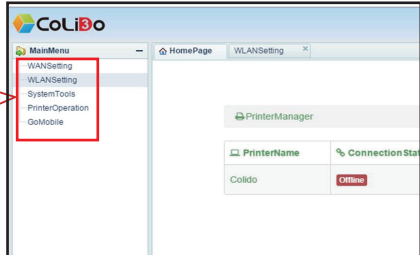
Configure Cable Setting	WANSetting	
Effect after reboot	WLANSetting	
Configure Wireless Setting	SystemTools	
Effect after reboot	PrinterOperation	
Enter into monitor page and printer operation page	GoMobile	
Enter into Smart phone operation interface		

NOTE: When powering off the printer, login to control panel page, under the “System Tools”, click on “ Power off” then switch off the printer.

### 7.4.1.2 Printer operation

Under the “Printer Operation” select “Operation” will go to printer operation page. Click on “Select file” to print the .GCO file.

## 7.4 Printing using WIFI communication

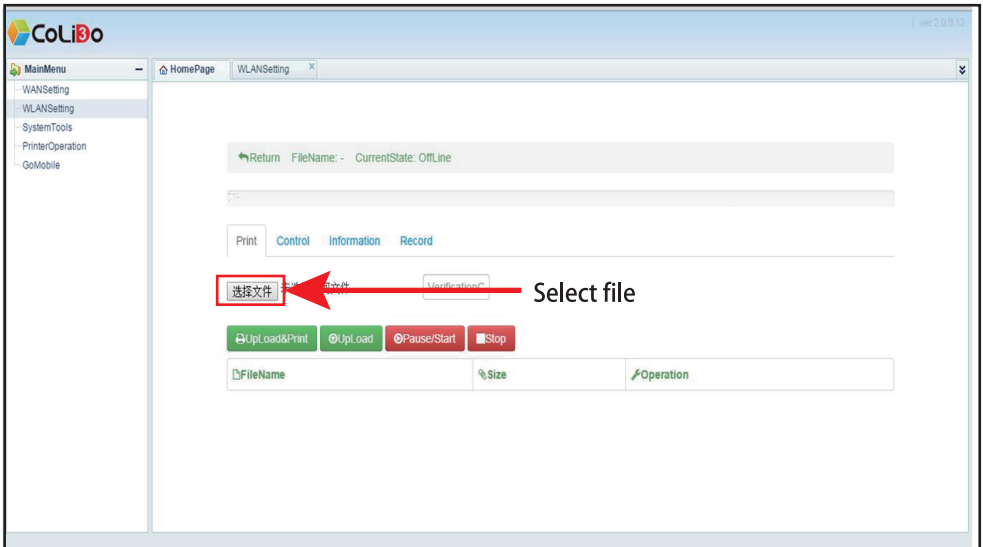
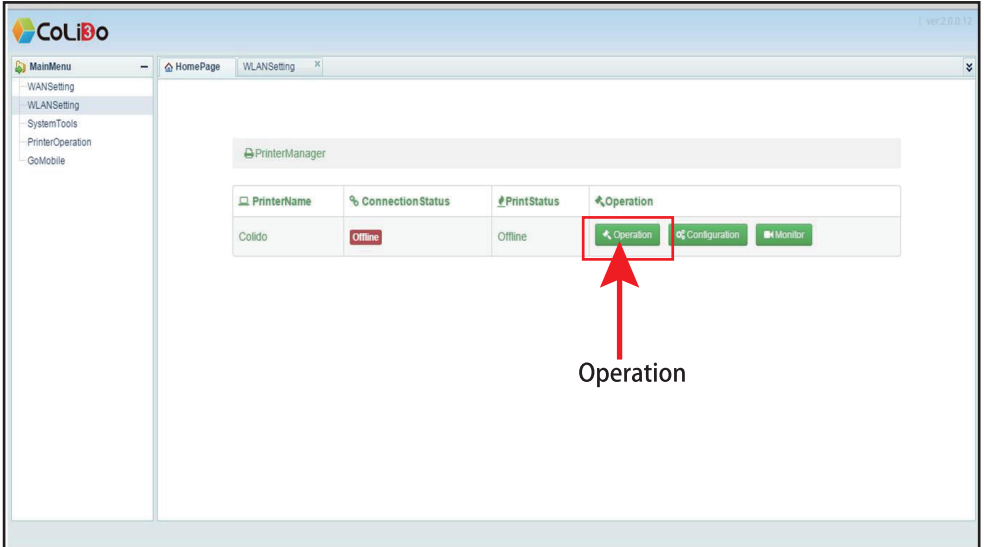

During the print, can use "Pause/Start" and "Stop" button to control. Select "Upload & Print" the model .GCO will show on the list and start print automatically; Select "Upload" the model .Gco will show on the list only. Click "Print" printer will start print the selected .GCO.

## 7.4 Printing using WIFI communication

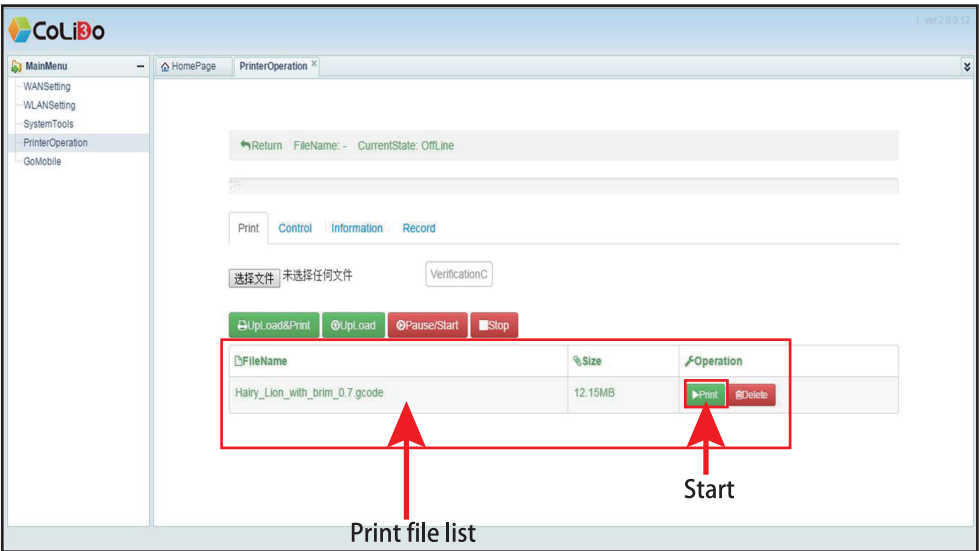

### 7.4.1.3 Other functions

Can adjust and check the print settings and file print information.

Control menu:

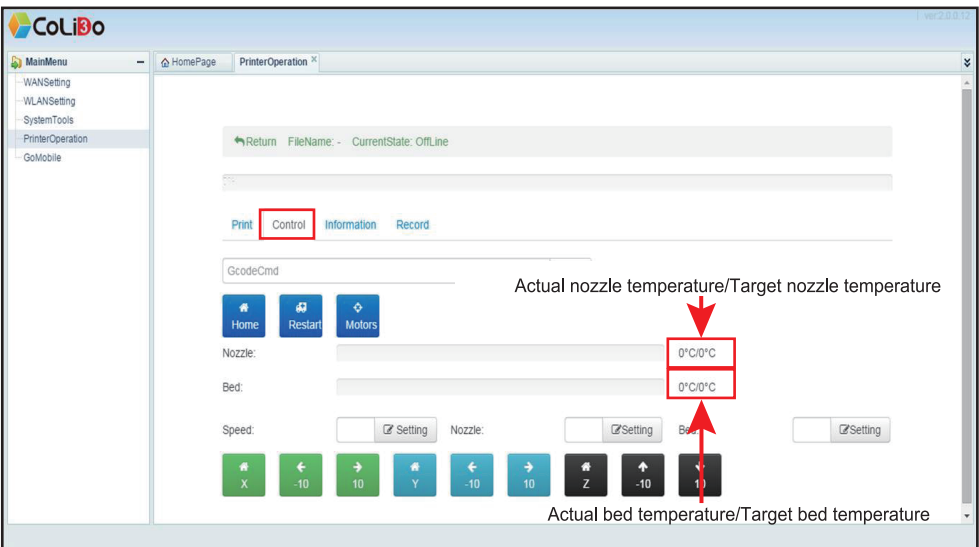

# 7.4 Printing using WIFI communication

## Information menu:

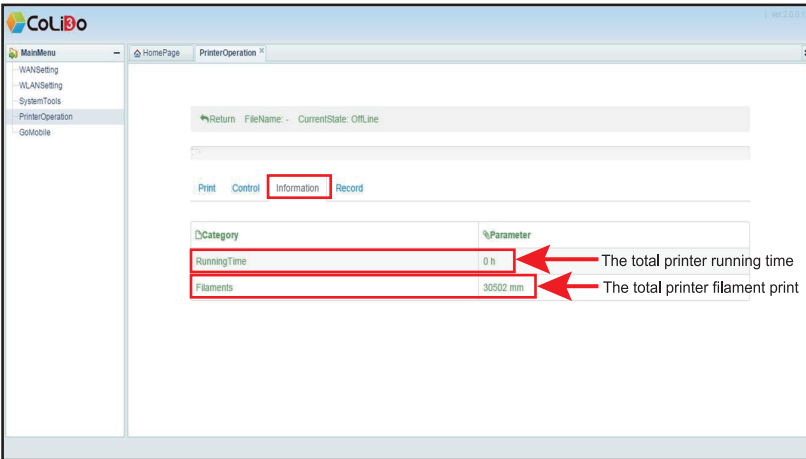

## Print Record:

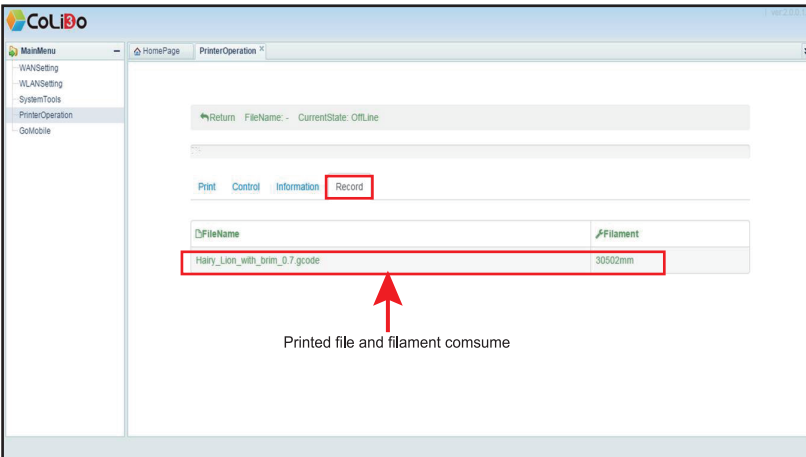

## Reset function

Reset button is inside the small hole located at the left side of the printer.

Press the reset button 1 second, Wifi will reboot;  
 Press the reset button 10 seconds, Wifi will restore to the factory settings.

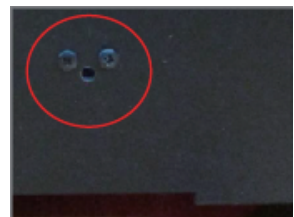



## 7.4 Printing using WIFI communication

### Monitor function

Under the WLAN Settings, select “Monitor” the click on “Start Preview” to start the monitoring the printer printing state.

NOTE: Every time click on “Start Preview” only have 15 seconds for the preview. Click again to refresh the page and start again.

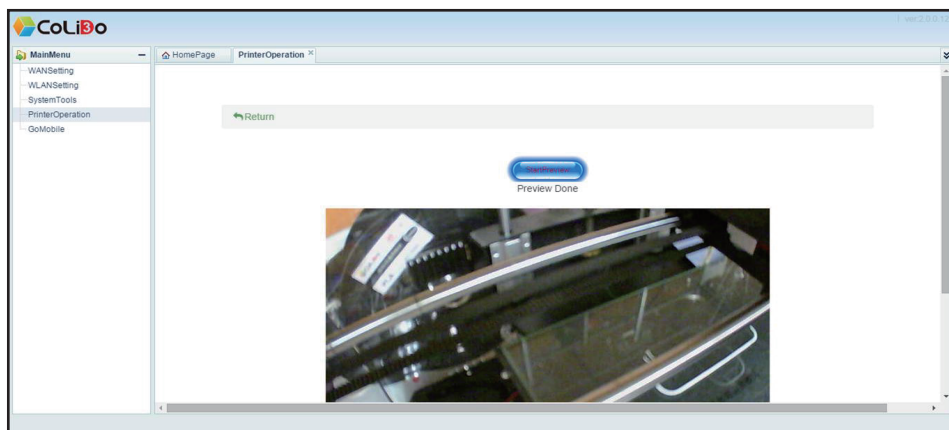
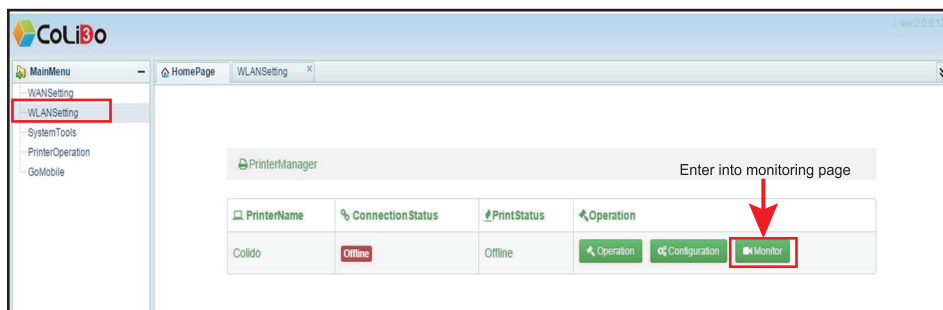

## 7.4 Printing using WIFI communication

### 7.4.2 Remote control

#### Step 1. Printer wireless relay setup

Refer 7.4.1.1 to connect printer with wifi, then open Google browser enter 10.10.11.1 to enter the CoLiDo 3D printer control web page. Under the “WLAN Settings” select “STA” then enter the router user name and password, click “Setup” to get STA IP as Fig. shown below.

Enter address 10.10.11.1

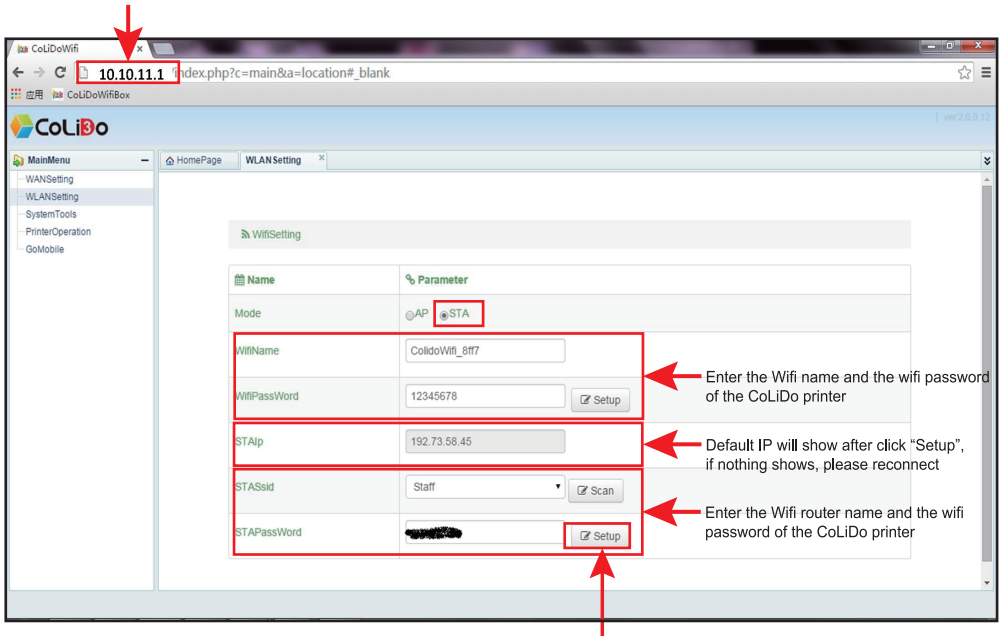

The screenshot shows the CoLiDo WiFi control web page. The browser address bar shows 10.10.11.1. The page title is "WLAN Setting". The "Mode" is set to "STA". The "WiFiName" is "ColidoWifi\_8ff7" and the "WiFiPassWord" is "12345678". The "STAIp" is "192.73.58.45". The "STASsid" is "Staff" and the "STAPassWord" is masked. Red boxes and arrows highlight the "STA" mode selection, the "WiFiName" and "WiFiPassWord" fields, the "STAIp" field, and the "STAPassWord" field with its "Setup" button. Red arrows also point to the "Setup" button for "WiFiPassWord" and the "Scan" button for "STASsid".

After enter the name and the password, click Setup to get STA IP.

If login with mobile, please select “To PC” to setup relay mode.



The screenshot shows the CoLiDo mobile app interface. The top bar is blue with the CoLiDo logo. Below the logo, there is a status bar showing "CurrentState:Offline Process:-". At the bottom, there are two buttons: "Colido" and "ToPC".

## 7.4 Printing using WIFI communication

### Step 2. Register with email

Connect with internet from router, enter “ www.colido-server.com ” in Google browser go to page as Fig. shown below.

Click “Register” .



Enter the valid email address and new password. The success message will be shown after click “Register” , and then click “OK” .

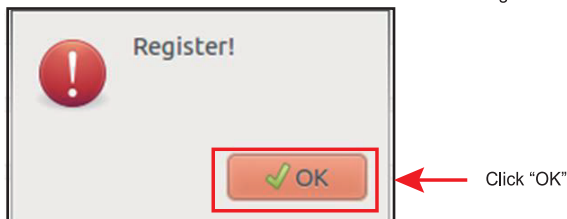
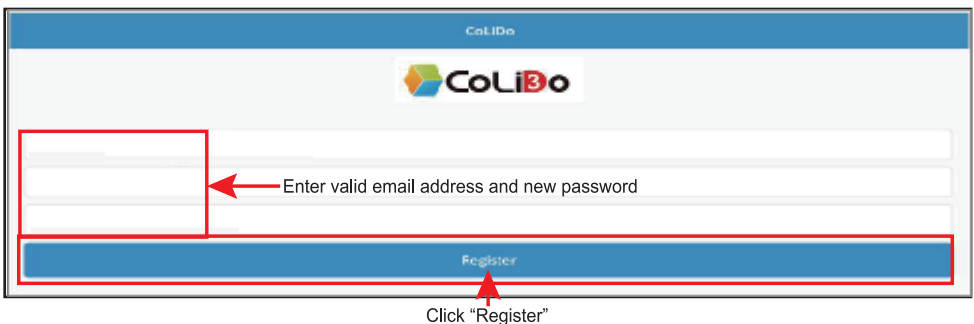

## 7.4 Printing using WIFI communication

### Step 3. Bind email

Connect with printer wifi, enter “10.10.11.1” in Google browser then select “RemoteConnect” under the “System Tools” menu.

Enter the registered email address and password, press “Connect” will pop-up the bind succeed message.

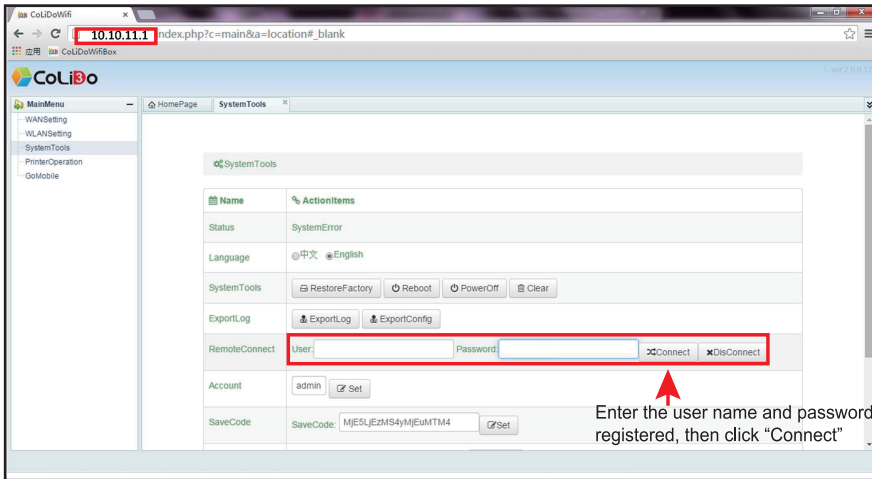

### Step 4. Remotely control printer

Connect with WAN internet, enter “www.colido-server.com” in Google browser.

Enter the bind email address and password, click “Login”. Click printer wifi enter into printer operation page.

NOTE: Click “Unbind” can remove the binding. One account can bind maximum 4 printers.

# 7.4 Printing using WIFI communication



Enter the user name and password connected with print wifi then click "Login"

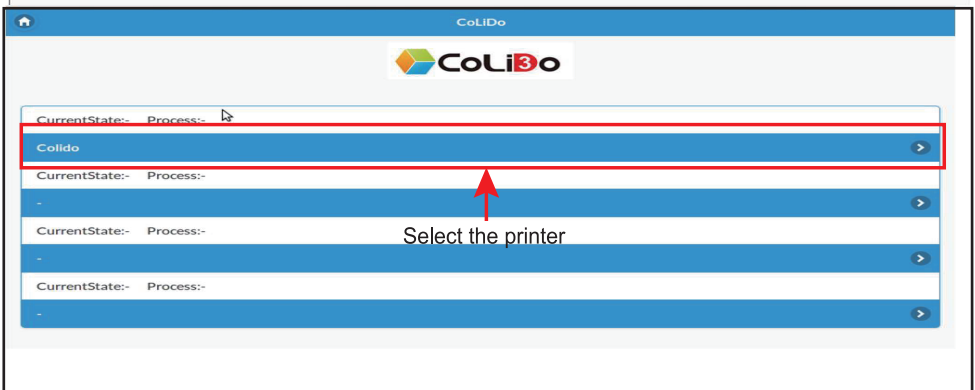
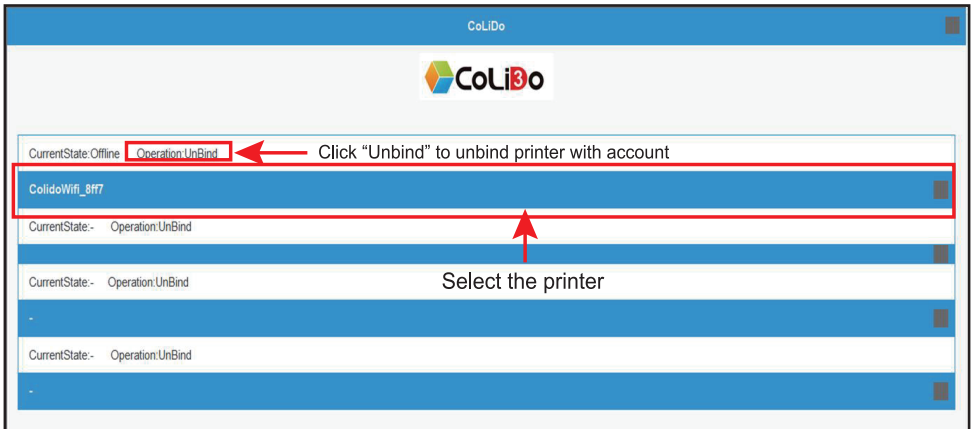

## 7.4 Printing using WIFI communication

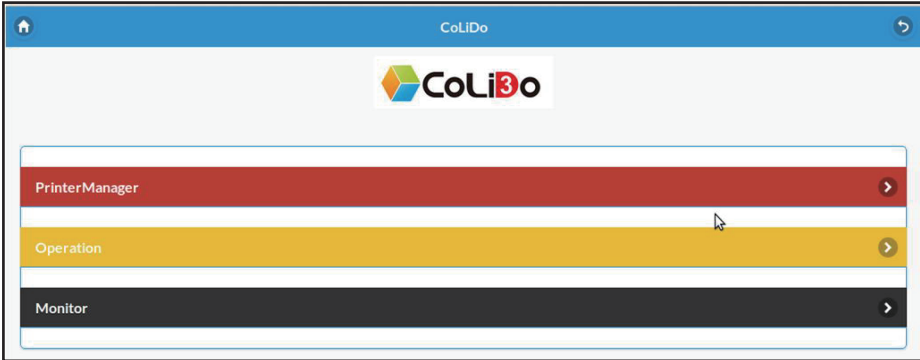

A

### a. "Print manage" page

Click "Select file" to select the .Gco model want to print.

Select "Upload & Print" the model .GCO will show on the list and start print automatically; Select "Upload" the model .Gco will show on the list only.

Click "Print" printer will start print the selected .GCO.

NOTE: The list can only show 10 recently uploaded files, if want other models, delete the file in the list then upload.

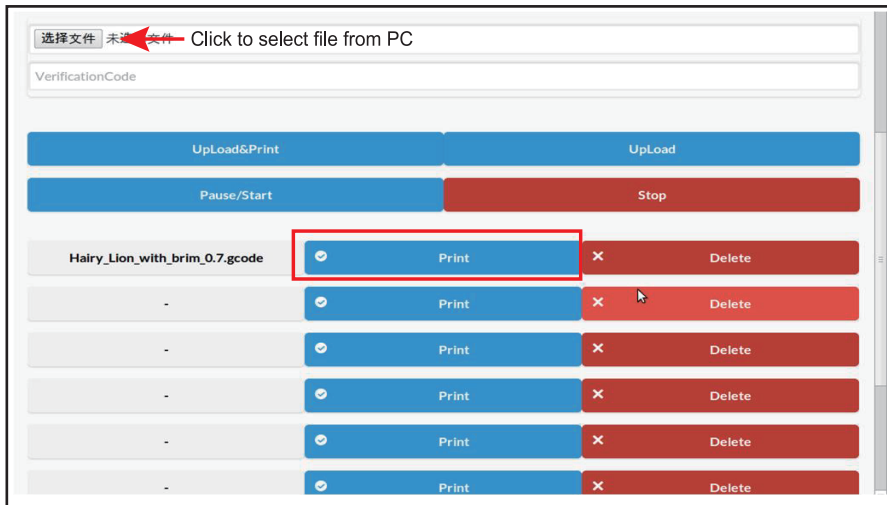

NOTE: The "Pause" and "Stop" function can be use during the printing. During the printer operation might have delay, please wait after click until the page refresh automatically.

## 7.4 Printing using WIFI communication

### b. "Operation" page

As Fig. A shown, click "Operation" . The operation page can setup the heated bed temperature, nozzle temperature, print speed, Gcode and so on.

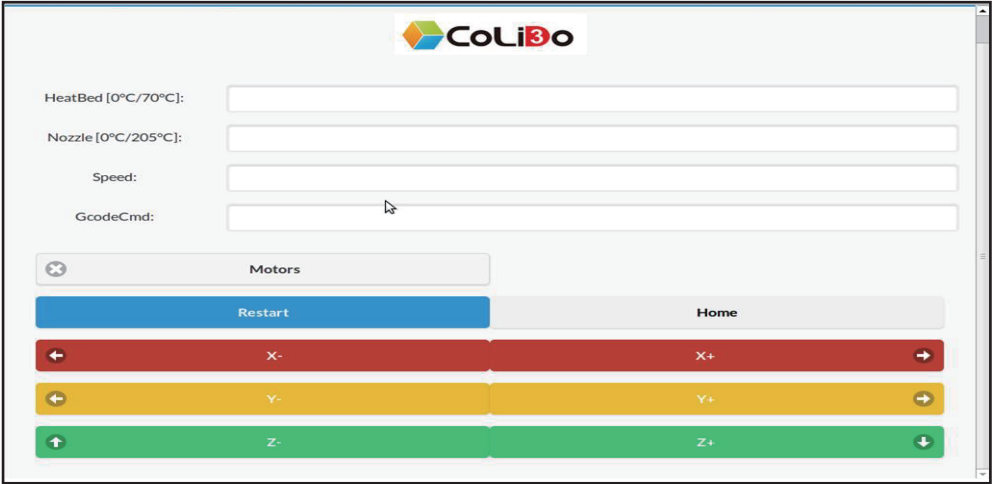

### c. "Monitoring" page

As Fig. A shown , click "Monitoring" to check the current print state.  
NOTE: Every click can only have one current preview snap shot.

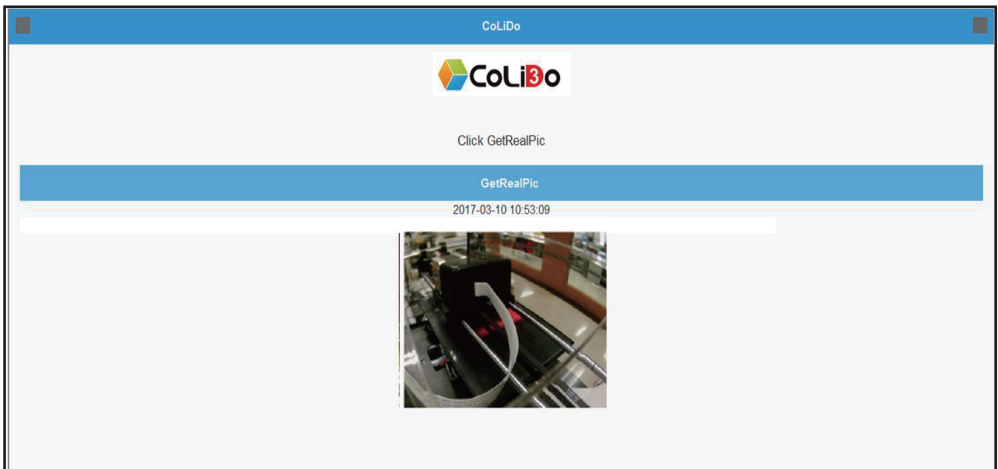

## 7.5 Repetier-Host Basic 3D Printing

- 3D object can be adjusted such as scale down/up X/Y/Z, rotate X/Y/Z, copy, mirror, autoposition and split before slice. After adjusting the object, It is better to click “Center Object”.

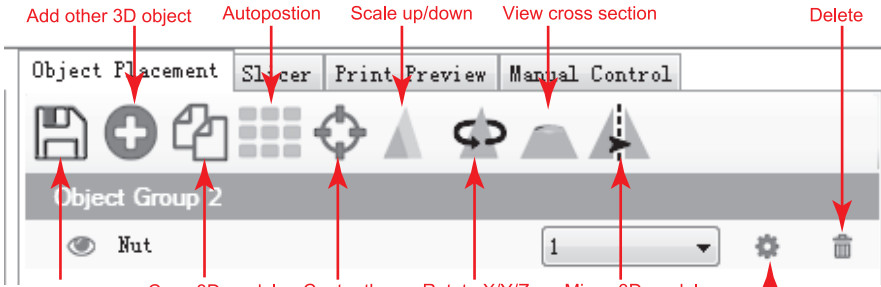

Add other 3D object    Autoposition    Scale up/down    View cross section    Delete

Object Placement    Slicer    Print Preview    Manual Control

Object Group 2

Save the adjusted 3D object    Copy 3D model to print more    Center the object    Rotate X/Y/Z    Mirror 3D model    Object Informations

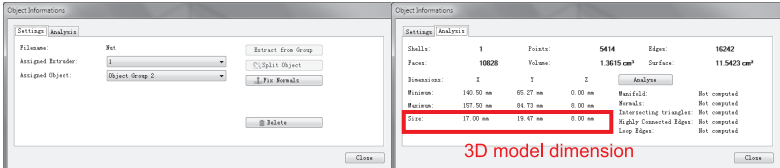

Dimensions	X	Y	Z
Minimum	140.50 mm	69.27 mm	0.00 mm
Maximum	157.50 mm	81.73 mm	0.00 mm
Size	17.00 mm	19.47 mm	0.00 mm

3D model dimension

- For 3D printing layer by layer base on FDM process, we suggest printing the model with OA structure. If printing the model with OB or OC structure (Call Overhang Printing), the parallel or downward layer will fall down on the model or on the platform due to no supporter to the layer. So, you need add supporter for overhang object.

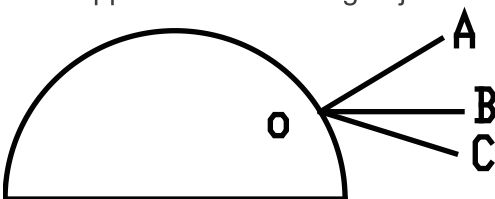

Remark:

- OA - the structure is upward to stretch
- OB - the structure is parallel to stretch
- OC - the structure is downward to stretch

- The 3D model must be closed surface or line to print base on FDM process. If below message appears, it is better to repair the object before printing. Recommend repair website: <https://netfabb.azurewebsites.net>.

The object is not manifold. This essentially means, that it is not watertight. This normally causes problems during slicing, resulting in unwanted results. We strongly advice to repair the file. One free repair service is: <https://netfabb.azurewebsites.net>



# 7.6 Repetier-Host Advanced 3D Printing

## 7.6.1 Slic3r settings

For printing setting, you can click “Configuration” to review or have your customized “Print/Filament/Printer Settings” in Slic3r for advanced user.

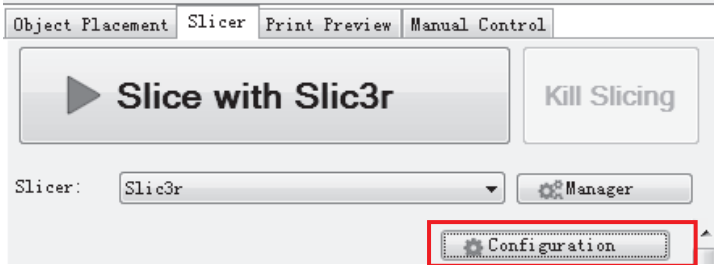

### 7.6.1.1 Print Settings (For example “CoLiDo standard”)

#### a. Layers and perimeters

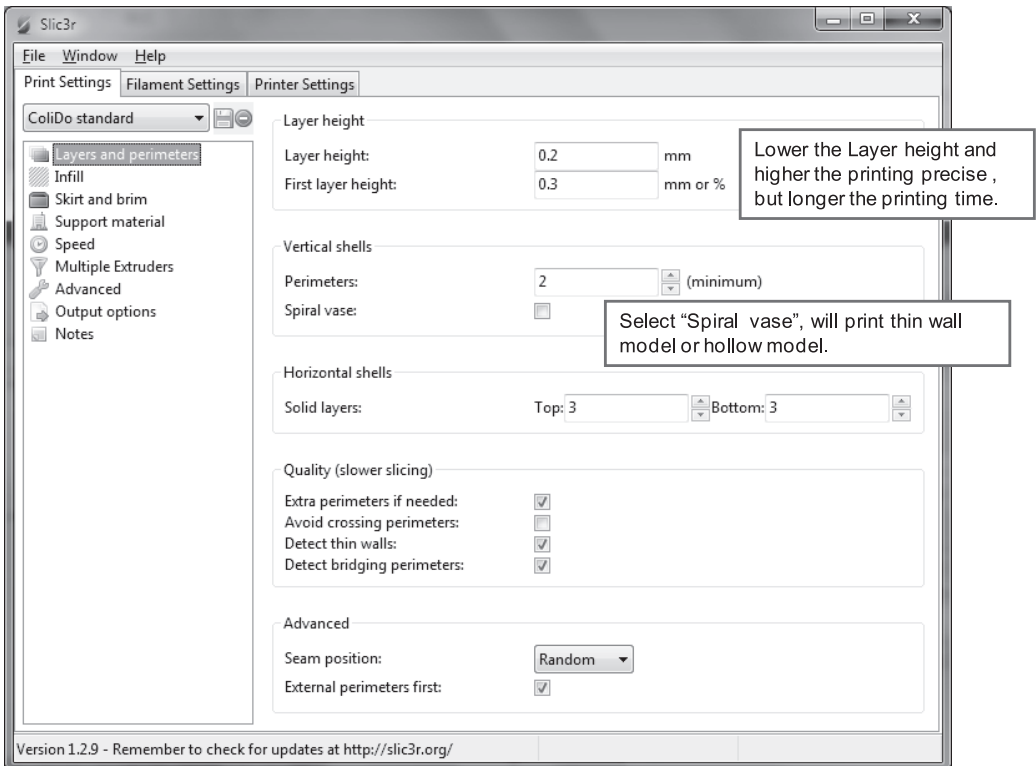

## b. Infill

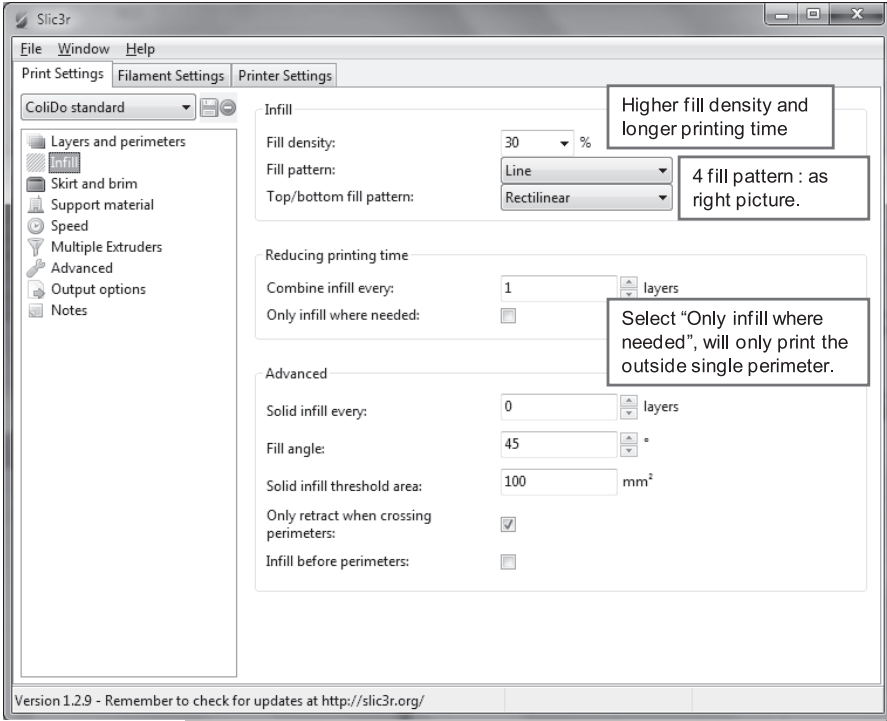

Line

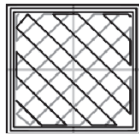

Rectilinear

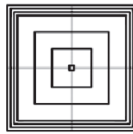

Concentric

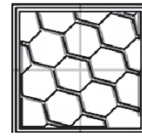

Honeycomb

## c. Skirt and brim

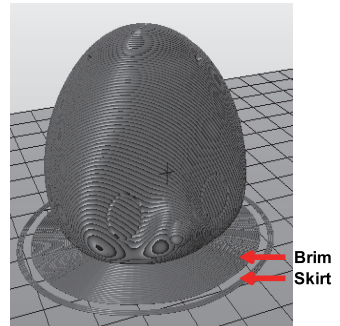
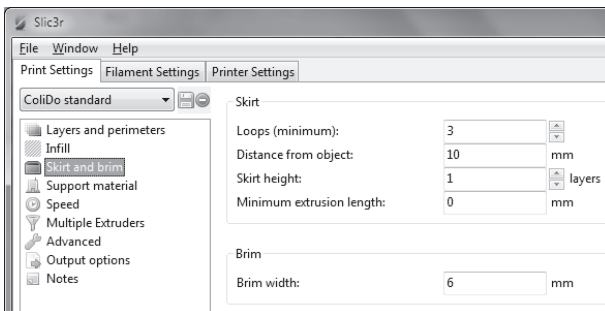

# 7.6 Repetier-Host Advanced 3D Printing

## d. Support Material

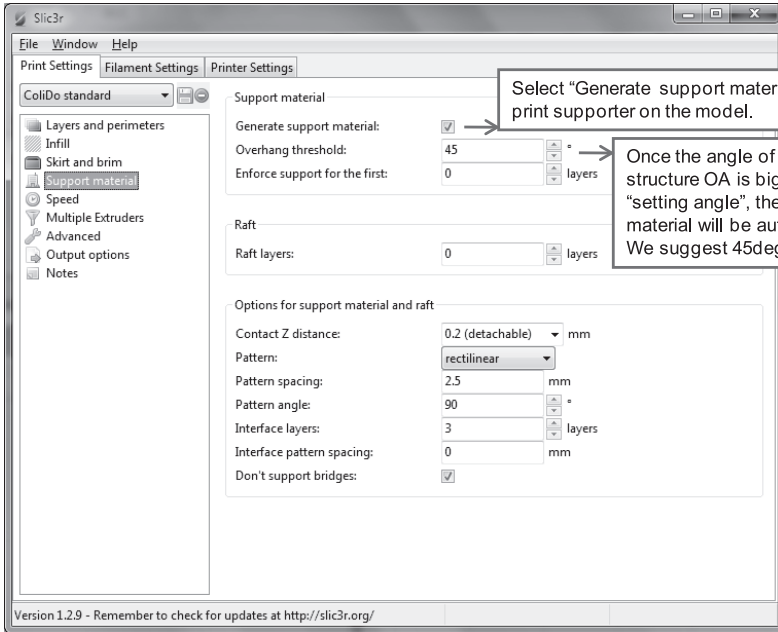

Support Material Pattern:



Rectilinear



Rectilinear Grid

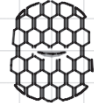

Honeycomb

## e. Speed

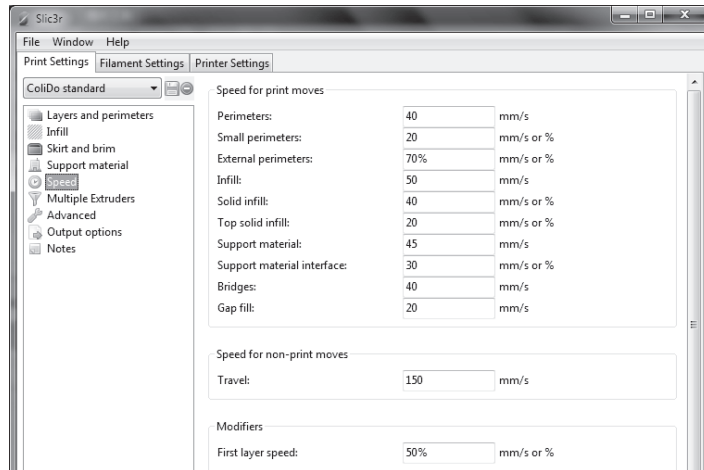

## 7.6 Repetier-Host Advanced 3D Printing

### 7.6.1.2 Filament Settings (For example “CoLiDo PLA\_70”)

#### a. Filament

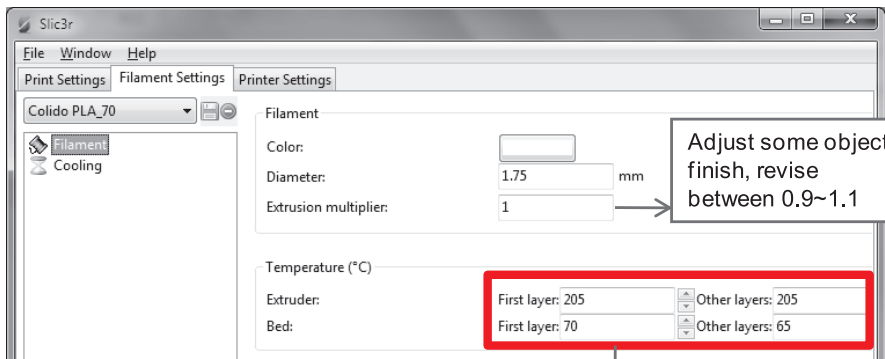

The screenshot shows the Slic3r interface with the 'Filament Settings' tab selected. The filament is set to 'Colido PLA\_70'. The 'Extrusion multiplier' is set to 1. A callout box points to this field with the text: 'Adjust some object finish, revise between 0.9~1.1'. The 'Temperature (°C)' section is highlighted with a red box, showing 'Extruder: First layer: 205, Other layers: 205' and 'Bed: First layer: 70, Other layers: 65'. A second callout box points to these temperature settings with the text: 'Setup the extruder and bed setting temperature'.

#### NOTE:

To revise the temperature, need click the up/down narrow instead of revise the number directly.

#### b. Cooling

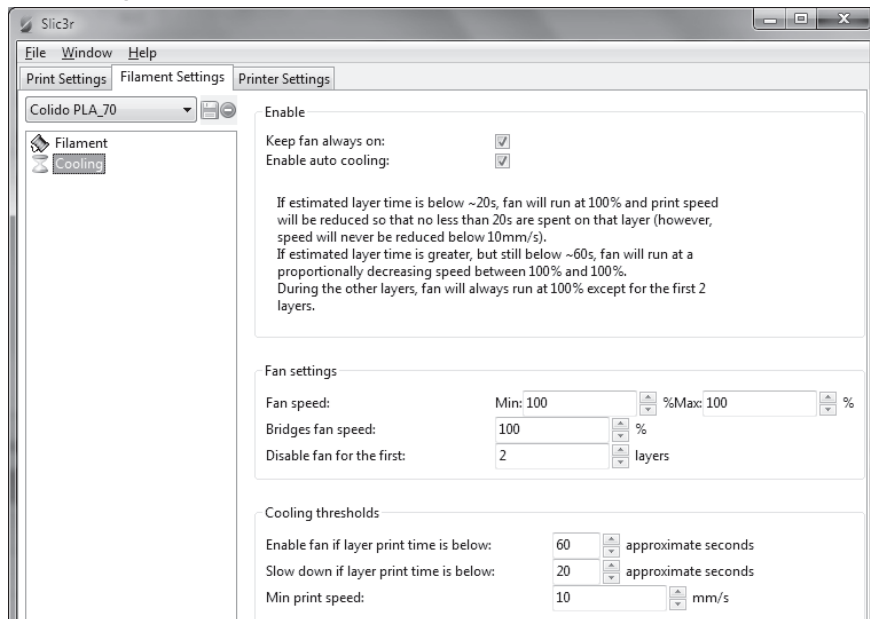

The screenshot shows the Slic3r interface with the 'Printer Settings' tab selected. The 'Cooling' section is active. It includes checkboxes for 'Keep fan always on' and 'Enable auto cooling', both of which are checked. Below these are instructions about fan speed based on layer time. The 'Fan settings' section includes 'Fan speed' (Min: 100, %Max: 100), 'Bridges fan speed' (100%), and 'Disable fan for the first' (2 layers). The 'Cooling thresholds' section includes 'Enable fan if layer print time is below' (60 approximate seconds), 'Slow down if layer print time is below' (20 approximate seconds), and 'Min print speed' (10 mm/s).

# 7.6 Repetier-Host Advanced 3D Printing

## 7.6.1.3 Printer Settings

### a. Extruder 1

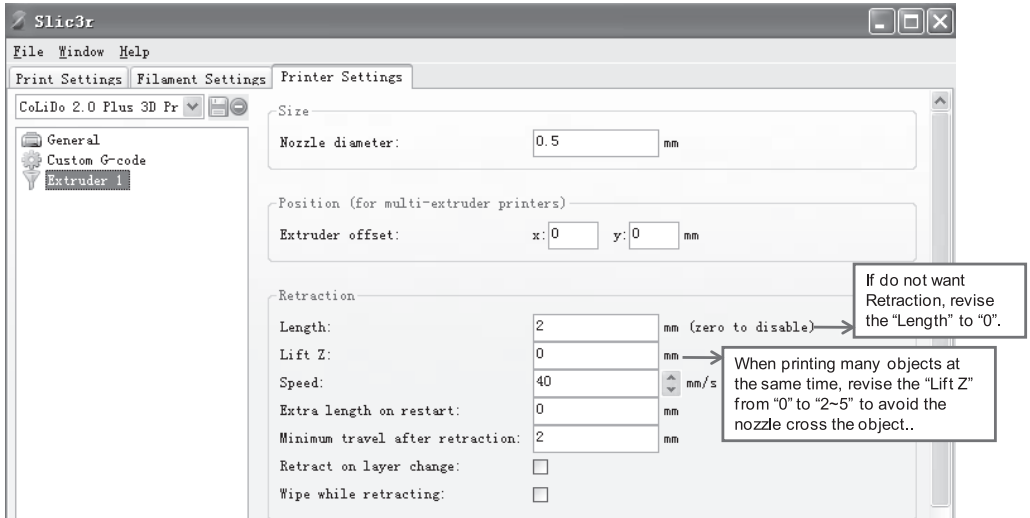

### b. Custom G-code

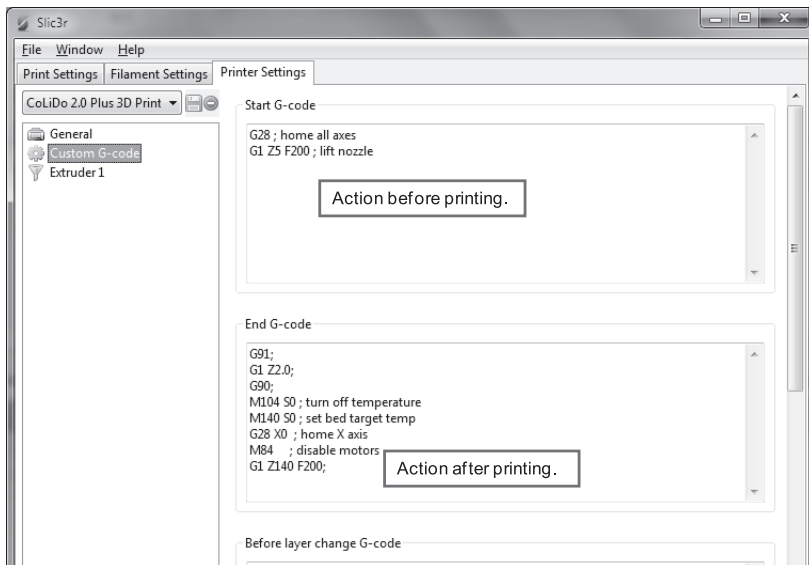

## 7.6 Repetier-Host Advanced 3D Printing

### 7.6.1.4 Save the settings

If you want to save the revised settings, click “Save” and have customized name. Then you can select customized name/settings when you slice.

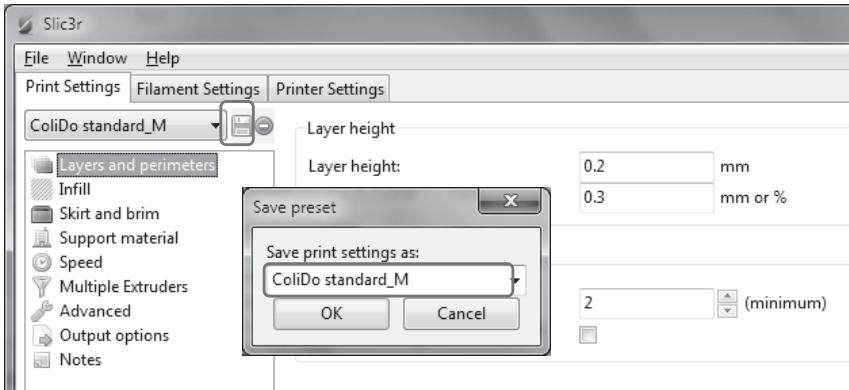

### 7.6.2 Other Skills

- a. Design supporter on the 3D model to avoid overhang structure (the supporter can be easily removed.)

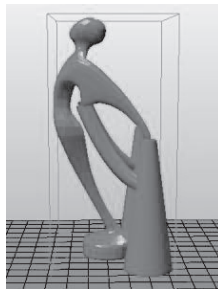

- b. When printing the hollowed-out object, it is better to lower the nozzle temperature by 5~10 degrees to avoid silky threads.
- c. If the object is bigger than the printer printing area, it is better to divide the object in several parts to print, then assemble together.  
If the object is smaller, it will easy moving on the platform and offset, it is better to copy printing several objects at one time.
- d. The printing environment has minor impact on the filament sticking condition.  
If cold printing environment, it is better to increase the nozzle temperature 5~10°C and vice versa.

# 7.6 Repetier-Host Advanced 3D Printing

## 7.6.3 CuraEngine

It is another slicer software to convert 3D model to g-code.

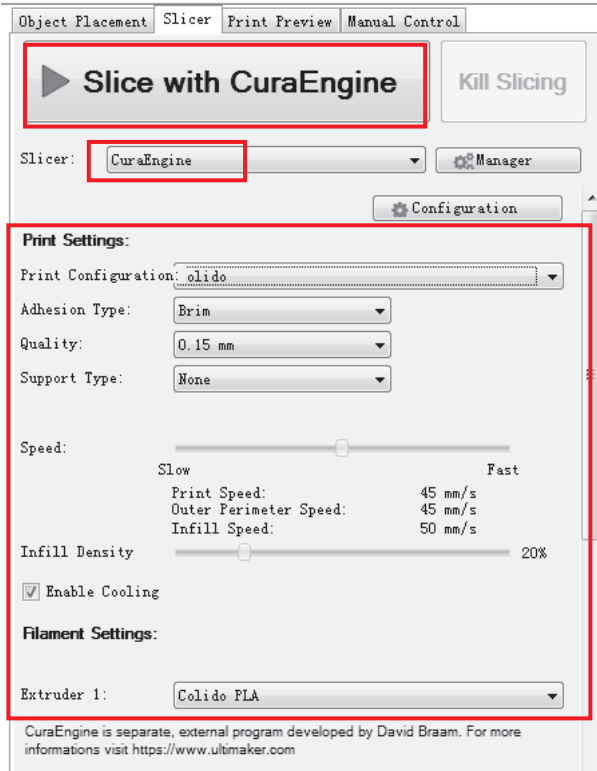

Step1: Select “CuraEngine”;

Step2: Select “Print Settings” and “Filament Settings”;

Step3: Click “Slice with CuraEngine”.

If you want to view or customize CuraEngine settings, click “Configuration”.

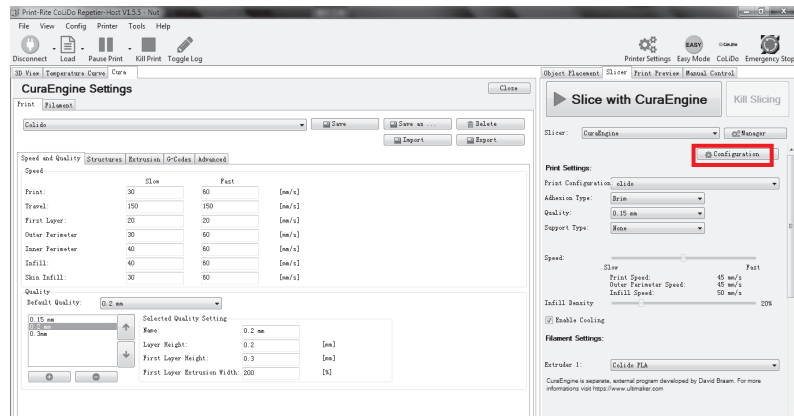

## Lubricate the Z-axis Screw Rod and the X-axis Idler Pulley

After printing around 50 hours, you should lubricate the Z-axis screw rod and the X-axis Idler Pulley.

To lubricate Z-axis screw rod, please follow up below process:

1. Prepare the lubricate (own by customer) such as SKF Bearing Grease .
2. Slowly rotate the Z screw rod to move up/down the platform of the 3D Printer.
3. Use a clean, lint-free cloth to spread the grease onto the top/bottom of the Z-axis screw rod.
4. Make sure the grease cover the inside of the Z-axis screw rod.

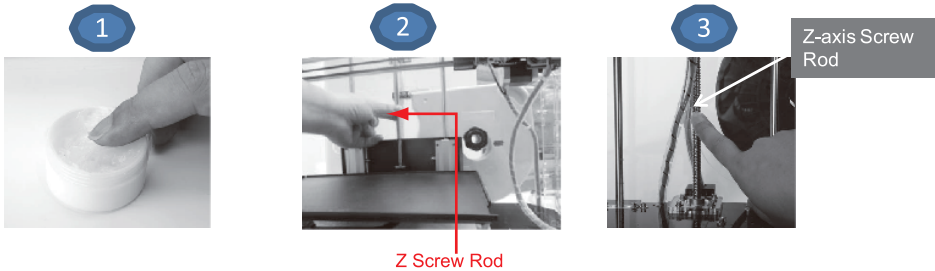

To lubricate X-axis / Y-axis rod, please follow up below process:

1. Prepare the lubricate (own by customer) such as SKF Bearing Grease .
2. Use a clean, lint-free cloth to spread the grease onto the X-axis / Y-axis rods.
4. Move the printer head left/right and forward/backward to have the grease application on the rods uniformly.

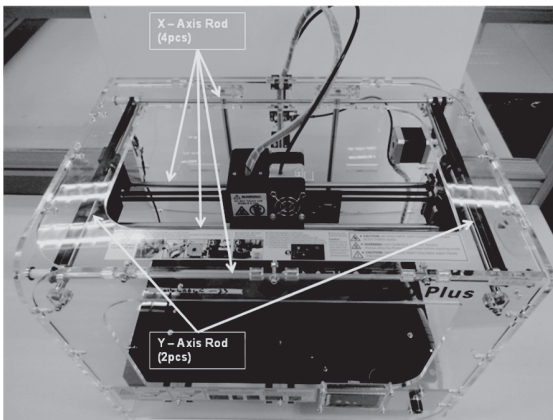





# Chapter 9 Display Error FAQ

Display Error	Cause	 Solution
Err: Check Filament	Filament used up or broken	<ol style="list-style-type: none"> <li>1. Remove the remain filament: Press down the printer head arm, push filament going down around 3cm, then pull out the filament;</li> <li>2. Reinstall the new filament: Filament must going through the detector, straighten the front of the filament, press down the printer head arm and send new filament through the guiding hole. Push down until filament flowing out from nozzle tip;</li> <li>3. Press on the rotating knob and select "Resume print".</li> </ol>
Err: Heating Failed	Nozzle temperature abnormal	<ol style="list-style-type: none"> <li>1. Restart printer;</li> <li>2. If the error showing up again during the printing, please contact with our customer service.</li> </ol>
Err: DDMK Failed	Recovery mode start	<ol style="list-style-type: none"> <li>1. Check the power connection;</li> <li>2. Restart printer;</li> <li>3. Press on the rotating knob, select "Resume print".</li> </ol>
Err: Data Failed	Data reading failed	<ol style="list-style-type: none"> <li>1. Restart printer;</li> <li>2. Resend the print command.</li> <li>3. Check the slicing file.</li> </ol>
Err: MAX TEMP	Nozzle temperature sensor error	Please contact with our customer service.
Err: MIN TEMP	Nozzle temperature sensor error	Please contact with our customer service.
Err: MAX TEMP BED	Heat bed sensor error	Please contact with our customer service.
Err: MIN TEMP BED	Heat bed sensor error	Please contact with our customer service.

Consumable (Filament)	
? Question	🔧 Solution
What is the PLA/ABS default setting temperature?	1. PLA: Nozzle temperature is 205°C, Platform temperature is 65~70°C; 2. ABS: Nozzle temperature is 220°C, Platform temperature is 100~110°C.
How to store the filament when the printer will be out of use for a long period of time?	If you do not use the filament for a long time, keep your filament spool or cartridge in a closed plastic bag to avoid the filament absorbing moisture. Also, ensure to insert the filament tip into the small hole of the spool to avoid filament entanglement when used next time.
How about the length of 1000g and 500g PLA/ABS filament?	1. 1000g: PLA around 320~330m, ABS around 390~400m; 2. 500g: PLA around 160~165m, ABS around 195~200m.
Can Prinrite filament be compatible with other 3D printers?	Yes, Prinrite filament is compatible with other FDM 3D printers, such as Makerbot, Afinia, Reprap, UP!, etc. The filament diameter should be 1.75mm.
3D Printer	
? Question	🔧 Solution
Does the printer support offline printing?	Support offline printing by using SD card.
How long will it take to print an object?	The required time depends on the object size and resolution level. The higher the resolution level, the slower the printing speed. The printer is configured with different print settings: Best, Standard, draft. After you select the printing setting to slice, the Repetier software will show the needed time.
How to fix the clogged nozzle?	1. Refer to chapter 6.6, once the nozzle reaches the setting temperature, please press the printer head arm and at the same time pull on the filament to extract it from the nozzle. 2. Refer to the label on the printer, clean the nozzle using the longer Allen Key in the accessory. 3. Disassemble the printer head by unlocking the screws on the Fan, clean the blocked filament inside the nozzle.
Can I adjust the parameter during printing?	For new users, we do not suggest adjusting the parameter during printing. For advanced users, you can push the knob to select "Control" to adjust Nozzle or Bed temperature and printing speed during printing.
How can I know if the printer is properly working?	Refer to chapter 6.2~6.4 in the user manual, print one of the test files in the SD Card supplied with the printer. (For example: PCT1.gco for PLA filament, ACT1.gco for ABS filament)
The filament cannot come out from the nozzle during printing?	1. The platform may be too close to the nozzle tip, which will prevent the filament from extruding from the nozzle. Please select "Prepare"->"Calibrate Mode" of the LCD screen to re-calibrate the platform. (refer to chapter 6.2 in the user manual) 2. Remove the filament from the printer head (refer to chapter 6.6 in the user manual), cut the filament tip flat, make a length of filament straight and re-load it into the printer head. Make sure that the filament is properly inserted into the nozzle receiving port. 3. Disassemble the printer head, check the gear which is pulling the filament into the nozzle. If there is a presence of filament powder residue, clean the gear using a brush. Check also if the gear tooth is damaged. If yes, replace the gear with a new one.
The printer makes a clicking noise when printing?	1. The filament is not properly inserted into the nozzle. Please unload the filament, cut the end of the filament flat and re-load it into the printer head. (refer to chapter 5.8) 2. It may be a short length of filament blocked in the nozzle from the last time it printed. Refer to chapter 6.6 in the user manual, heat the nozzle and push the blocked filament into the nozzle tip by loading new filament, the blocked filament will be melted out.
The filament cannot be removed from the printer head?	1. Check if the nozzle actual temperature reaches the setting temperature; 2. Refer to chapter 6.6 in the user manual, when the nozzle actual temperature reaches the setting temperature, press the printer head arm and push a bit of filament into the nozzle until the filament comes out from the nozzle, then pull the filament out quickly.
The printed sample sticks to the platform too tightly and cannot be removed?	1. Please wait a few minutes for the platform and the printed samples to cool down, then remove the printed sample. 2. If the printed samples still stick to the platform tightly, please carefully remove them using a scalpel.

3D Printer	
? Question	 Solution
The printed object cannot stick to the platform?	<ol style="list-style-type: none"> <li>1. Make the temperature setting correct. PLA, nozzle temperature is 205°C, platform temperature is 70°C; ABS: nozzle temperature is 220°C, platform temperature is 110C. Make sure the selected setting is matched with the material you are using.</li> <li>2. Re-calibrate the platform to meet "calibration standard condition" (The test sheet must be lay down flat in the platform and the test sheet must be touching the nozzle tip).</li> <li>3. Make sure that the glass platform you are using is correct base on the filament material. No dust, oil or damage coating on the glass platform. If yes, please clean up using lint-free cloth or replace the platform.</li> </ol>
The printer cannot read the files on SD card and cannot start to print with SD Card?	<ol style="list-style-type: none"> <li>1. Turn off the printer and turn on again the printer.</li> <li>2. If the printer still cannot read the file, please check if the files saved in SD card in .GCO format and correct file name (English word, number, underline, blank space). If the file is not .GCO format, please convert it to .GCO format through Repetier-Host software. (refer to chapter 7.3 in user manual).</li> <li>3. Please double check if the SD card insert into the SD card slot well. If not, please re-insert.</li> </ol>
How to clean the excess filament around the nozzle?	Preheat up the nozzle to 220°C by rotate LCD knob to select "Control"- "Temperature"- "Nozzle". Once the nozzle actual temperature reaches the setting temperature 220°C, clean the nozzle using the lint-free cloth or tissue.
Need pause/resume during printing?	<ol style="list-style-type: none"> <li>1. During printing with SD Card, push the LCD knob and rotate it to select "Pause print"; Then push LCD knob and rotate it to select "Resuming print". NOTE: Please be more patient after selecting "Pause print", the printer need ~30s to buffer.</li> <li>2. During printing with Repetier control, click "Pause Job" and then click "Continue Printing".</li> </ol>
Need stop during printing?	<ol style="list-style-type: none"> <li>1. During printing with SD Card, push the LCD knob and rotate it to select "Stop print". After stop, the printing can be resumed. The printer head will go to home position and the nozzle &amp; bed temperature will cooldown. NOTE: Please be more patience after selecting "Stop print", the printer need ~30s to buffer.</li> <li>2. During printing with Repetier control, click "Kill Job". The printer head will stop moving and the nozzle &amp; bed temperature will cooldown.</li> <li>3. If the printing still not stop after above, please turn off the printer, wait ~10s and turn it back on. Then push the LCD knob and select "Prepare"- "Auto Home" so the printer head go to home position.</li> </ol>
Download files from 3D model website cannot be printed well?	<ol style="list-style-type: none"> <li>1. Refer to chapter 7.2 &amp; 7.3 in user manual, re-setup Repetier-Host and select correct filament material to print.</li> <li>2. The printed object will have different printing effect with different filament material. For example, if the object cannot be printed well with ABS filament, you can test to print with PLA filament.</li> <li>3. Check if the object shape is closed drawing, if it need scale up/down, rotating, adding supporter, etc to meet FDM process by refer to 7.5. If Repetier-Host shows warning message when load the object, it is better to repair the object through the website: <a href="https://netfabb.azurewebsites.net">https://netfabb.azurewebsites.net</a></li> </ol>
The STL file cannot be sliced to gco file in Repeater software?	<p>When load STL file to Repetier software, the object will show all dark blue color in the 3D view window, it means that the file can be sliced.</p> <ol style="list-style-type: none"> <li>1. If the object show some red and some green, it mean the object has unclosed line or surface and cannot be sliced. Also, Repetier-Host will show warning message to suggest repairing the object.</li> <li>2. If the object is not touch with he printing area or exceed the printing area, please click " place in the middle, or click " scale down and then place in center.</li> </ol>
How to set parameters for the 3D printer to insert them in Repetier/Slic3r software?	<ol style="list-style-type: none"> <li>1. The Repetier-Host software of the printer has standard settings for selecting to use directly.</li> <li>2. For the advanced user, click "Configuration" to revise the parameters. Refer to 7.5 in user manual for detail.</li> </ol>

3D Printer	
? Question	🔧 Solution
How to do if the LCD Display show "Err: MINTEMP"?	CoLiDo printer operation temperature is 15°C~32°C, please place the printer under the right room temperature such the printer can have good printing. Once change the printer to place in the right room temperature, need turn off and turn on back to refresh the printer.
How much the printing speed?	The printer printing speed is 20~120mm/s.
Repetier-Host software cannot connect to 3D printer though the software installed correctly?	<ol style="list-style-type: none"> <li>1. Ensure the printer connect to computer with USB cable and turn on;</li> <li>2. Refer to chapter 7.2 , make sure that the selection of COM port in printer setting is right. The port should be the last one when turn on the printer and matched with COM port in Device Manager. Once connected, the Temperature Curve will be moving. NOTE: "COM1" cannot be used.</li> </ol>
The printed object easy to warp when printing?	<ol style="list-style-type: none"> <li>1. Adjust the adjusting knob to have the nozzle tip more close to the platform.</li> <li>2. The contact area of the object to the platform is too small, use Repetier software to add brim before slicing: Click"Configure"- "Brim", add the Brim width with "8~10mm".</li> <li>3. Add the nozzle temperature higher 5~10°C.</li> <li>4. Maybe have a cover to cover the top of the printer when printing ABS to avoid the heat dissipation too fast.</li> </ol>
How to evaluate if the filament enough or not to print the object?	After convert STL file to GCO file in Repetier-Host software, customer can see the needed filament usage (Length) of printing the object . Customer can evaluate the actual filament length is enough to meet the needed filament length.
How to clean the coating glass platform if the remain filament stick on it?	<ol style="list-style-type: none"> <li>1. Clean the glass platform using lint-free cloth or wet tissue. Do not use alcohol or any cleaning chemical solution in cleaning the glass platform, it will damage the glass coating.</li> <li>2. If still cannot clean the remain filament on the glass platform, please replace a new one.</li> </ol>
How to download Repetier for Mac OS or Linux?	Go to website <a href="http://Repetier.com">Repetier.com</a> to free download the Repetier software for operation system Mac OS or Linux.
How to get free 3D modeling software?	Website to download free 3D modeling software: <a href="http://www.hongkiat.com/blog/25-free-3d-modelling-applications-you-should-not-miss/">http://www.hongkiat.com/blog/25-free-3d-modelling-applications-you-should-not-miss/</a>
How to get free 3D model to print?	<ol style="list-style-type: none"> <li>1. Use 3D modelling software such as UG, 3DMAX and above free software to design your 3D model file and save as STL format.</li> <li>2. Use scanner to scan 3D model . We recommend scanner "Structure Sensor"which need work with APPLE IPAD.</li> <li>3. Download 3D model from Website: <a href="http://www.thingiverse.com">http://www.thingiverse.com</a> <a href="http://www.hongkiat.com/blog/download-free-stl-3d-models/">http://www.hongkiat.com/blog/download-free-stl-3d-models/</a> <a href="http://www.hongkiat.com/blog/60-excellent-free-3d-model-websites/">http://www.hongkiat.com/blog/60-excellent-free-3d-model-websites/</a></li> </ol>
CoLido Printer parts life time ?	Nozzle : 1500hours PLA and ABS Glass Platform : 300 times use in same location Motor : 3000 hours End Stop (Limit Switch) : 10000 times Belt : 2000hours Linear bearing : 3000hours Fan : 20000h Display panel : 20000h Rotary knob : 100000 times

If you need more assistance, kindly please contact with us:

Email: [3Dsupport@utec.com.mo](mailto:3Dsupport@utec.com.mo)